

# Roxburgh RES90 Series EMI Filters

## Single-phase Drive Rated EMI Filters

The Roxburgh RES90 Series filters feature excellent attenuation performance suitable for noisy applications where increased filter performance is required. They are specifically designed as line filters for single-phase 120/240V AC and DC drives.

RES90 Series are a multi-stage EMC filter with very high differential and common mode attenuation rated up to 250V. The filters can be integrally mounted in cabinet or chassis hardware. Available in 1/4" quick disconnect type (RES90F) and screw terminal type (RES90S).

### Features

- 0-240VAC/DC, 0-400 Hz, single-phase
- 1A - 30A models
- Very high performance type in a metal case
- 1/4" quick connect or screw terminals
- Panel mount

**Filter performance curves are available on item page at [www.AutomationDirect.com](http://www.AutomationDirect.com)**

### Applications

- Ideally suited for products that must conform to part 15, FCC regulations
- Single-phase AC and DC drives
- Digital electronics
- Personal computers and peripherals
- Office automation
- Building automation
- Monitors and display units
- Household and consumer devices
- Machinery design

### Standards and Certifications



RES90 EMI Filters		
Part Number	Price	Description
<a href="#">RES90F01</a>	\$20.00	EMI Input filter, 1-phase 120/240VAC, multi-stage drive grade, 1A
<a href="#">RES90F03</a>	\$23.50	EMI Input filter, 1-phase 120/240VAC, multi-stage drive grade, 3A
<a href="#">RES90F06</a>	\$34.50	EMI Input filter, 1-phase 120/240VAC, multi-stage drive grade, 6A
<a href="#">RES90F10</a>	\$50.00	EMI Input filter, 1-phase 120/240VAC, multi-stage drive grade, 10A
<a href="#">RES90F16</a>	\$53.00	EMI Input filter, 1-phase 120/240VAC, multi-stage drive grade, 16A
<a href="#">RES90S20</a>	\$66.00	EMI Input filter, 1-phase 120/240VAC, multi-stage drive grade, 20A
<a href="#">RES90S30</a>	\$85.00	EMI Input filter, 1-phase 120/240VAC, multi-stage drive grade, 30A

General Specifications	
<b>Voltage Rating</b>	0-240V AC/DC, 0-400 Hz
<b>Voltage Max.</b>	250V
<b>Voltage Withstand</b>	3000VDC/2 sec
<b>Phase</b>	1
<b>UL/IEC Pollution Class</b>	Degree II
<b>Humidity</b>	93% RH (non-condensing)
<b>Overload Current</b>	135% 2Hrs, 150% 60s
<b>Insulation Resistance</b>	500VDC >3.5 MΩ
<b>Climate Class (IEC 60068-1)</b>	25/100/21
<b>Temperature Rise</b>	60°C
<b>Temperature Rating</b>	-13 to 212°F (-25 to 100°C)
<b>Flammability (UL94)</b>	V-2
<b>Case Material</b>	Nickel Plated Steel
<b>Altitude*</b>	1000m (3000m with derating)
<b>Mounting Clearance</b>	>50mm Gap
<b>Agency Approval**</b>	cURus: File# E191581 (Standard: UL1283 & C22.2 No.8)

\* Derate 1% per 100m after 1000m; Max 3000m.

\*\*To obtain the most current agency approval information, see the Agency Approval Checklist section on the specific component part number web page.

# Roxburgh RES90 Series EMI Filters

Specifications							
Parameter	RES90F01	RES90F03	RES90F06	RES90F10	RES90F16	RES90S20	RES90S30
Max. Power (kW)	0.25	0.75	1.5	2.5	4	5	7.5
Current Rating (A)	1	3	6	10	16	20	30
SCCR Rating (kA)	5						
Ingress Protection	IP20						
Terminal Style	1/4" Quick Disconnect					M4 Stud	
Torque (lb·in [N·m])	N/A					11.5 [1.3]	
Operational Leakage Current (mA)	0.5		0.67		1.02		
Total Resistance (Line to Load) (mΩ)	750	250	100	500	15	50	300
Residual Voltage (V@5s)	1V@5s						
Heat Dissipation (W)	0.75	2.25	3.6	5	12.8	20	7.2
Weight (lb [kg])	0.18 [0.08]	0.44 [0.20]		1.0 [0.45]	0.92 [0.42]		1.2 [0.55]

## Dimensions

mm [inches]

**RES90F01**

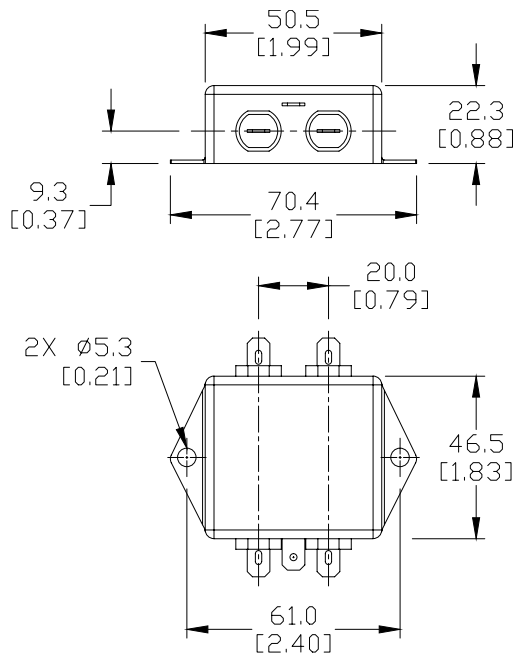

**RES90F03  
RES90F06**

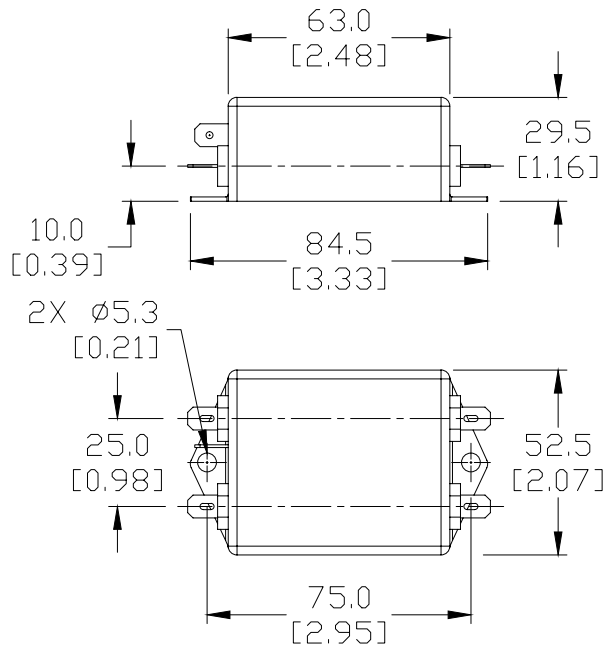

# Roxburgh RES90 Series EMI Filters

## Dimensions

mm [inches]

**RES90F10**  
**RES90F16**

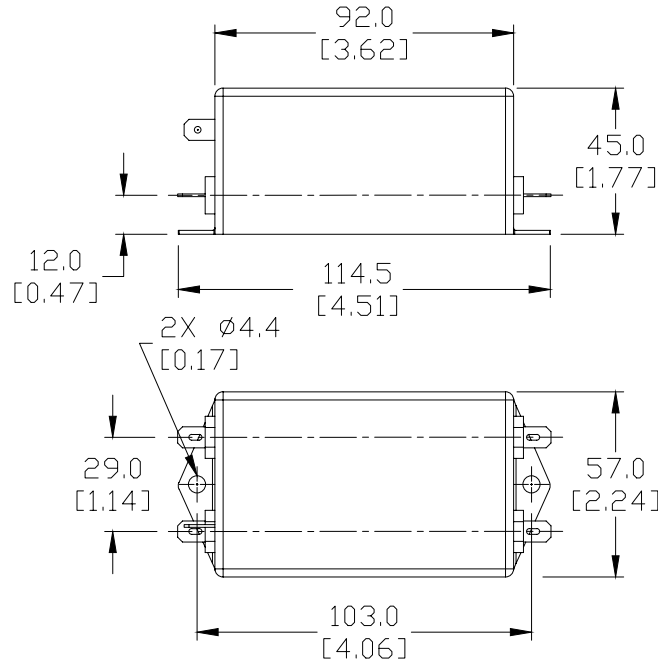

**RES90S20**  
**RES90S30**

