

# C-more Operator Panels Overview

## Getting started

Installing the software and configuring the **C-more** panel is simple. You will need the following to successfully connect, configure and send a project to the panel:

- **C-more** HMI - 6in, 7in wide, 8in, 10in, 10in wide, 12in, 15in or [EA9-RHMI](#)
- **C-more** Programming Software, p/n [EA9-PGMSW](#)
- **C-more** programming cable, USB or Ethernet
- 12-24 VDC switching power supply or the optional **C-more** AC Power Adapter, p/n [EA-AC](#)
- Personal Computer - to run **C-more** programming software
- PLC communications cable (serial or Ethernet) to connect the **C-more** HMI to your controller

Part Number	Description	Price
<a href="#">EA9-T6CL-R</a>	<b>C-more</b> EA9 series touch screen HMI, 6in color TFT LCD, 320 x 240 pixel, QVGA, LED backlight, supports (1) serial and (2) USB ports and (1) memory card slot.	\$564.00
<a href="#">EA9-T6CL</a>	<b>C-more</b> EA9 series touch screen HMI, 6in color TFT LCD, 320 x 240 pixel, QVGA, LED backlight, supports (3) serial, (1) Ethernet and (2) USB ports, (1) memory card slot and (1) audio line out.	\$788.00
<a href="#">EA9-T7CL-R</a>	<b>C-more</b> EA9 series touch screen HMI, 7in color TFT LCD, widescreen, 800 x 480 pixel, WVGA, LED backlight, supports (1) serial, (1) Ethernet and (2) USB ports and (1) memory card slot.	\$545.00
<a href="#">EA9-T7CL</a>	<b>C-more</b> EA9 series touch screen HMI, 7in color TFT LCD, widescreen, 800 x 480 pixel, WVGA, LED backlight, supports (3) serial, (1) Ethernet and (2) USB ports, (1) memory card slot and (1) audio line out.	\$629.00
<a href="#">EA9-T8CL</a>	<b>C-more</b> EA9 series touch screen HMI, 8in color TFT LCD, 800 x 600 pixel, SVGA, LED backlight, supports (3) serial, (1) Ethernet and (2) USB ports, (1) memory card slot and (1) audio line out.	\$1,096.00
<a href="#">EA9-T10CL</a>	<b>C-more</b> EA9 series touch screen HMI, 10in color TFT LCD, 800 x 600 pixel, SVGA, LED backlight, supports (3) serial, (1) Ethernet and (2) USB ports, (1) memory card slot and (1) audio line out.	\$1,410.00
<a href="#">EA9-T10WCL</a>	<b>C-more</b> EA9 series touch screen HMI, 10in color TFT LCD, widescreen, 1024 x 600 pixel, WSVGA, LED backlight, supports (3) serial, (1) Ethernet and (2) USB ports, (1) memory card slot and (1) audio line out.	\$767.00
<a href="#">EA9-T12CL</a>	<b>C-more</b> EA9 series touch screen HMI, 12in color TFT LCD, 800 x 600 pixel, SVGA, LED backlight, supports (3) serial, (1) Ethernet and (2) USB ports, (2) memory card slots, (1) HDMI video out and (1) audio line out.	\$1,987.00
<a href="#">EA9-T15CL-R</a>	<b>C-more</b> EA9 series touch screen HMI, 15in color TFT LCD, 1024 x 768 pixel, XGA, LED backlight, supports (1) serial, (1) Ethernet and (2) USB ports and (2) memory card slots.	\$1,451.00
<a href="#">EA9-T15CL</a>	<b>C-more</b> EA9 series touch screen HMI, 15in color TFT LCD, 1024 x 768 pixel, XGA, LED backlight, supports (3) serial, (1) Ethernet and (2) USB ports, (2) memory card slots, (1) HDMI video out and (1) audio line out.	\$2,223.00
<a href="#">EA9-RHMI</a>	<b>C-more</b> EA9 series headless HMI, supports (2) serial, (1) Ethernet, (2) USB ports and (1) HDMI audio/video out and (1) memory card slot.	\$414.00
<a href="#">EA9-PGMSW</a>	<b>C-more</b> Windows programming software, CD or free download. For use with <b>C-more</b> EA9 series touch panels. Requires USB or Ethernet connection to touch panel.	\$11.00 on CD, or FREE download
<a href="#">USB-CBL-AB3</a>	AutomationDirect programming cable, USB A to USB B, 3ft cable length. For use with <b>C-more</b> HMIs, Do-more and Productivity series CPUs and most USB devices.	\$9.00
<a href="#">USB-CBL-AB6</a>	AutomationDirect programming cable, USB A to USB B, 6ft cable length. For use with <b>C-more</b> HMIs, Do-more and Productivity series CPUs and most USB devices.	\$11.75
<a href="#">USB-CBL-AB10</a>	AutomationDirect programming cable, USB A to USB B, 10ft cable length. For use with <b>C-more</b> HMIs, Do-more and Productivity series CPUs and most USB devices.	\$27.00
<a href="#">USB-CBL-AB15</a>	AutomationDirect programming cable, USB A to USB B, 15ft cable length. For use with <b>C-more</b> HMIs, Do-more and Productivity series CPUs and most USB devices.	\$31.00

# C-more Selection Guide & Specifications

Specification	EA9 Headless HMI
<b>Part Number</b>	<a href="#">EA9-RHMI</a>
<b>Price</b>	\$414.00
<b>Display</b>	No Display
<b>Weight</b>	0.59 lb [269g]
<b>Project Memory</b>	82MB
<b>Number of Screens</b>	Up to 999 screens – limited by project memory
<b>Realtime Clock</b>	Realtime clock built into panel, backed up for 30 days at 25°C
<b>Calendar – Month / Day / Year</b>	Yes - monthly deviation 60sec (Reference)
<b>Serial Port 1</b>	15-pin D-sub female – RS232C, RS-422/485
<b>Serial Port 2</b>	3-wire terminal block – RS-485
<b>USB Port – Type B</b>	USB 2.0 High speed (480 Mbps) Type B - Download/Program Max cable length - 15 ft.
<b>USB Port – Type A</b>	USB 2.0 High speed (480 Mbps) Type A - for USB device options Max cable length - 15ft Bus Power – Less than 500mA at 5VDC
<b>Supported Touch Screen</b>	ELO™ Single Touch Resistive/SAW, EETI eGalax Single Touch Resistive and pCap Compatible with AutomationDirect Atlas Monitors. See the EA-RHMI user manual for more compatible touchscreen monitors
<b>Ethernet Port</b>	10/100 Base-T, auto MDI/MDI-X
<b>Ethernet Port - Expansion Module</b>	<a href="#">EA-ECOM</a>
<b>Audio Line Out</b>	Audio supported through HDMI connection
<b>Mic In (Future)</b>	N/A
<b>SD Card Slot</b>	1 slot support max 2GB (SD), max 32GB (SDHC)
<b>HDMI Video Out</b>	HDMI Type A Port
<b>HDMI Supported Resolutions</b>	640 x 480 (VGA) 60Hz 720 x 480 (SD) 60Hz 1024 x 768 (XGA) 60Hz 1280 x 720 (HD) 60Hz With automatic negotiation function for HDMI displays
<b>Supply Power</b>	10.2-26.4 VDC Class 2, Use Class2 and SELV (Safety Extra-Low Voltage) Circuit and Limited Energy Circuit (LEC), Reverse Polarity Protected
<b>Power Consumption</b>	12.0 W 1.00 A @ 12VDC 0.50 A @ 24VDC
<b>Internal Fuse (non-replaceable)</b>	4.0 A
<b>Altitude</b>	Up to 2000m (6562ft)
<b>Operating Temperature</b>	0 to 50°C (32 to 122 °F); Maximum surrounding air temperature rating: 50°C (122°F) IEC 60068-2-14 (Test Nb, Thermal Shock)
<b>Storage Temperature</b>	-20 to 60°C (-4 to 140°F) IEC 60068-2-1 (Test Ab, Cold) IEC 60068-2-2 (Test Bb, Dry Heat) IEC 60068-2-14 (Test Na, Thermal Shock)
<b>Humidity</b>	5-95% RH (non-condensing)
<b>Environment</b>	For use in Pollution Degree 2 environment, no corrosive gases permitted
<b>Noise Immunity</b>	(EN61131-2) EN61000-4-2 (ESD): 4kV (Contact Discharge) 2kV/4kV/8kV (Air Discharge) EN61000-4-3 (RFI): 10V/m (80MHz-1GHz), 3V/m (1.4GHz-2.0GHz) 1V/m (2.0GHz-2.7GHz) EN61000-4-4 (FTB): 2kV ,positive/negative, 5kHz(DC Power Port) EN61000-4-5 (Serge): 0.5kV line to line 0.5kV line to earth EN61000-4-6 (Conducted): 10V, 0.15MHz - 80MHz EN61000-4-8 (Power frequency magnetic field immunity): 30A/m (Local test) RFI, (145MHz, 440MHz 10W @10cm) Impulse 1000V @ 1µs pulse
<b>Withstand Voltage</b>	1000VAC, 1min. (FG to Power supply )
<b>Insulation Resistance</b>	> 10M ohm @ 500VDC (FG to Power supply )
<b>Vibration</b>	IEC60068-2-6 (Test Fc) 5-9Hz: 3.5mm amplitude, 9-150Hz 1.0G 10 sweep cycles per axis on each of 3 mutually perpendicular axes
<b>Shock</b>	IEC60068-2-27 (Test Ea) 15G peak, 11ms duration, 3 shocks in each direction per axis, on 3 mutually perpendicular axes
<b>Emission</b>	EN55011 Class A (Radiated RF emission)
<b>Agency Approvals</b>	UL61010, E157382 CE (EN61131-2), RoHS (2011/65/EU) CUL Canadian C22.2

# C-more EA9-RHMI Headless HMI

## EA9-RHMI



**\$414.00**

C-more EA9 series headless HMI supports HD 1280 x 720 (60Hz) pixel screen resolution HDMI output, 800MHz CPU, 12-24 VDC powered, includes (2) serial ports, USB 2.0 Type A and B ports and one Ethernet port. Supports (1) SD memory card. Compatible with EA9-PGMSW programming software version 6.50 or later.



## Features

- Ethernet 10/100 Base-T port (program/download & PLC communication)
- Expansion Module Support
- Use EA-ECOM for second Ethernet Port
- Remote Internet access
- Serial PLC interface (RS-232/422/485)
- One built-in SD memory card slot
- 12-24 VDC powered
- HDMI audio/video out
- 82MB project memory
- Data logging
- 0 to 50°C [32 to 122°F] operating temperature range
- DIN rail mountable
- UL, cUL & CE agency approvals
- 2-year warranty from date of purchase

Function	Available
Ethernet	Yes
USB	Yes
SD Card	Yes
Audio Out	Yes
HDMI Audio/Video Out	Yes
Expansion Module	Yes

## Dimensions

Units: inches [mm]

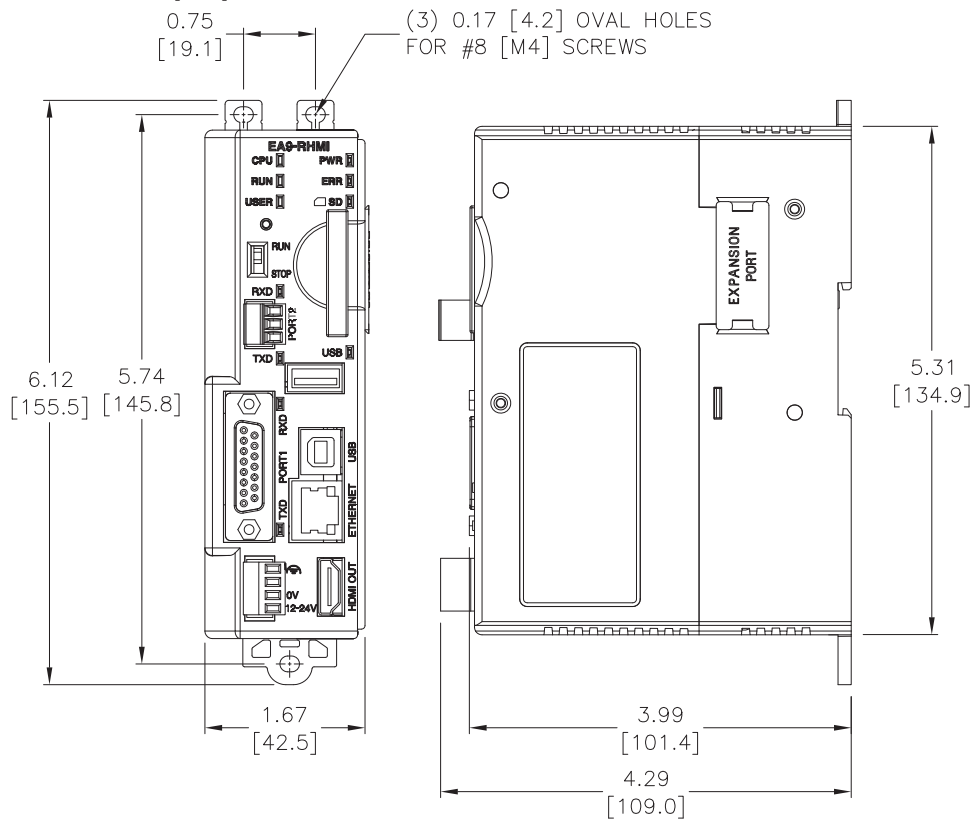

See our website [www.AutomationDirect.com](http://www.AutomationDirect.com) for complete engineering drawings.

# C-more EA9-RHMI Communication Ports

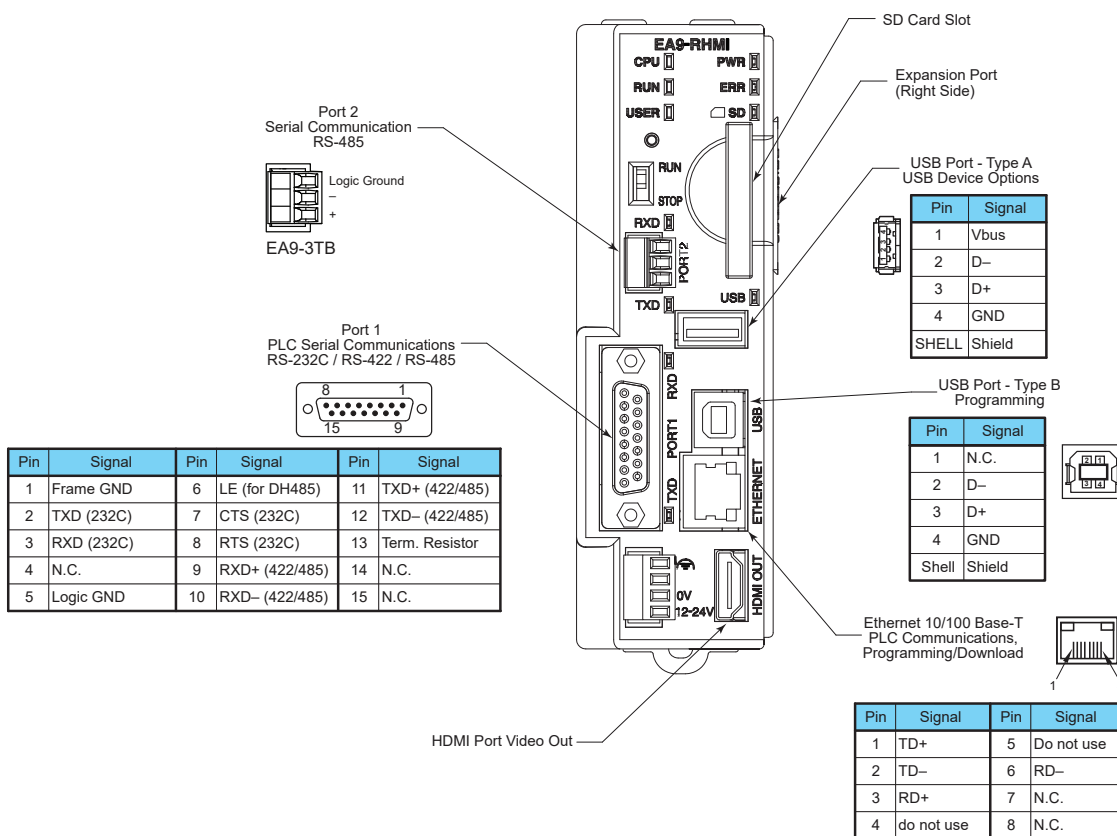

## Ethernet Port

The Ethernet port has several uses:

- Download program to panel
- Communicate to PLCs/PCs
- Send e-mail
- Access FTP server
- Act as a Web server
- Remote Internet access

The Ethernet port has an RJ-45 8-wire modular connector with green and yellow LEDs.

- The yellow LED indicates network speed – off for a 10 Mbps connection and illuminated for a 100 Mbps connection.
- The green LED indicates link status and illuminates when a link is established.

## Expansion Port

The expansion port supports the [EA-ECOM](#) module to provide a second Ethernet Port.

## USB Port B

Program *C-more* via the USB programming port. It's fast and easy, with no baud rate settings, parity, or stop bits to worry about. We stock standard USB cables for your convenience. USB Port B can be used to upload or download projects to and from a PC.

## USB Port A\*

The Universal Serial Bus (USB) Port A can be used to connect various USB HID (Human Input Device) devices to the panel, such as the following:

- USB touchscreen (ELO™ Single Touch Resistive/SAW, EETI eGalax Single Touch Resistive and pCap touchscreens)
- USB mouse
- USB keyboard
- USB flash drives ([USB-FLASH](#))
- USB barcode scanner
- USB card scanner

*C-more* can log data to the USB flash drive as well as load projects to the panel from the pen drive. You can also back up project files and panel firmware.

\* 500mA maximum current available. Powered USB hub may be required for some devices

## Serial Port

**Port 1** - Connect to your serial controller network via Port 1. Port 1 is a 15-pin port that supports RS-232 or RS-422/485.

**Port 2** - Connect your RS-485 network via Port 2. Port 2 is provided with a 3-wire removable terminal block.

## HDMI Out Port

[EA9-RHMI](#) includes an HDMI Type A port to provide video / audio output to a projector or remote monitor. Supported resolutions are...

- 640 x 480 (VGA) 60Hz
- 720 x 480 (SD) 60Hz
- 1024 x 768 (XGA) 60Hz
- 1280 x 720 (HD) 60Hz

# C-more Communication Protocols & Cables

Compatibility Table				
PLC Family	Model	Protocols		
Allen-Bradley	MicroLogix 1000, 1100, 1200, 1400, 1500, SLC 5-01/02/03	DH485/AIC/AIC+		
	MicroLogix 1000, 1100, 1200, 1400 and 1500 SLC 5-03/04/05	DF1 Half Duplex; DF1 Full Duplex		
	ControlLogix™, CompactLogix™, FlexLogix™			
	PLC-5	DF1 Full Duplex		
	ControlLogix, CompactLogix, FlexLogix - Tag Based	DF1 Half Duplex; DF1 Full Duplex		
	ControlLogix, CompactLogix, FlexLogix - Generic I/O Messaging	EtherNet/IP Server		
	ControlLogix, CompactLogix, FlexLogix - Tag Based			
	Micrologix 1100, 1400 & SLC5/05, all via native Ethernet port	EtherNet/IP Client		
	MicroLogix 1000, 1100, 1200, 1400, 1500 & SLC 5-03/04/05, all via ENI Adapter			
	Micro 800 series	Modbus RTU Modbus TCP		
Micro 800 series - Tag Based	DF1 Full Duplex EtherNet/IP Client			
<b>Modbus RTU</b>	Modbus RTU devices	Modbus RTU		
<b>Modbus TCP/IP</b>	Modbus TCP/IP devices	Modbus TCP/IP		
<b>GE</b>	90/30, 90/70, Micro 90, VersaMax Micro	SNPX		
	90/30, Rx3i	SRTP Ethernet		
<b>Mitsubishi</b>	FX Series	FX Direct		
	Q02, Q02H, Q06H, Q12H, Q25H	Q CPU		
	Q, QnA Serial	QnA Serial		
<b>Omron</b>	Q, QnA Ethernet	QnA Ethernet		
	C200 Adapter, C500	Host Link		
<b>Modicon</b>	CJ1/CS1 Serial, CJ1/CS1 Ethernet	FINs		
	984 CPU, Quantum 113 CPU, AEG Modicon Micro Series 110 CPU: 311-xx, 411-xx, 512-xx, 612-xx	Modbus RTU		
<b>Siemens</b>	S7-200 CPU, RS-485 Serial	PPI		
	S7-200 CPU, S7-300 CPU, S7-400, S7-1200 CPU, S7-1500; Ethernet	Ethernet ISO over TCP		
<b>Productivity Series</b>	all	AutomationDirect P3000 Serial		
		AutomationDirect P3000 Ethernet		
<b>Do-more</b>	all	Do-more Serial		
		Do-more Ethernet		
<b>CLICK</b>	all	AutomationDirect Modbus (CLICK)		
<b>Direct LOGIC</b>	DL05/DL06	all	K-Sequence DirectNET Modbus (Koyo addressing)	
		H0-ECOM/H0-ECOM100	Direct LOGIC Ethernet	
	DL105	all	K-Sequence	
		D2-230	K-Sequence	
	DL205	D2-240	K-Sequence DirectNET	
		D2-250/D2-250-1/D2-260/D2-262	K-Sequence DirectNET Modbus (Koyo addressing)	
		D2-240/D2-250-1/D2-260 using D2-DCM	DirectNET Modbus (Koyo addressing)	
		H2-ECOM/H2-ECOM100	Direct LOGIC Ethernet	
		DL305	D3-330/330P (Requires the use of a Data Communications Unit)	DirectNET
			D3-340	DirectNET
	D3-350		K-Sequence DirectNET Modbus (Koyo addressing)	
			DirectNET Modbus (Koyo addressing)	
	D3-350 using D3-DCM		DirectNET Modbus (Koyo addressing)	
	DL405		D4-430	K-Sequence DirectNET
		D4-440	K-Sequence DirectNET	
		D4-450/D4-454	K-Sequence DirectNET Modbus (Koyo addressing)	
			DirectNET Modbus (Koyo addressing)	
		All with D4-DCM	DirectNET Modbus (Koyo addressing)	
		H4-ECOM/H4-ECOM100	Direct LOGIC Ethernet	
		H2-WinPLC (Think & Do) Live V5.2 or later and Studio any version	Think & Do Modbus RTU (serial port)	
	H2-WinPLC (Think & Do) Live V5.5.1 or later and Studio V7.2.1 or later	Think & Do Modbus TCP/IP (Ethernet port)		

Cable Description	Cable Part Number	Price
AutomationDirect communication cable, 15-pin male D-sub to 6-pin RJ12, shielded, 9.8ft/3m cable length. For use with <b>C-more</b> or <b>C-more</b> Micro panel and AutomationDirect PLCs with RJ12 ports.	<a href="#"><u>EA-2CBL</u></a>	\$23.00
AutomationDirect communication cable, 15-pin male D-sub to 15-pin D-sub HD15 male, shielded, 3m/9.8ft cable length. For use with <b>C-more</b> or <b>C-more</b> Micro panel and a DL06, D2-250(-1), D2-260 or D2-262 (bottom port) CPU.	<a href="#"><u>EA-2CBL-1</u></a>	\$23.50
AutomationDirect communication cable, 15-pin male D-sub to 4-pin RJ11, shielded, 3m/9.8ft cable length. For use with <b>C-more</b> or <b>C-more</b> Micro panel and a D3-340 CPU top or bottom port.	<a href="#"><u>EA-3CBL</u></a>	\$23.00
AutomationDirect communication cable, 15-pin male D-sub to 15-pin male D-sub, shielded, 3m/9.8ft cable length. For use with <b>C-more</b> or <b>C-more</b> Micro panel and a DL405 (top port) CPU.	<a href="#"><u>EA-4CBL-1</u></a>	\$23.00
AutomationDirect communication cable, 15-pin male D-sub to 25-pin male D-sub, shielded, 3m/9.8ft cable length. For use with <b>C-more</b> or <b>C-more</b> Micro panel and a D2-DCM, D3-232-DCU, D3-350 (bottom port) or DL405 (bottom port) CPU.	<a href="#"><u>EA-4CBL-2</u></a>	\$24.00
AutomationDirect communication cable, 15-pin male D-sub to 8-pin male mini DIN, shielded, 3m/9.8ft cable length. For use with <b>C-more</b> or <b>C-more</b> Micro panel and an Allen-Bradley Micrologix CPU.	<a href="#"><u>EA-MLOGIX-CBL</u></a>	\$35.00
AutomationDirect communication cable, 15-pin male D-sub to 9-pin female D-sub, shielded, 3m/9.8ft cable length. For use with <b>C-more</b> or <b>C-more</b> Micro panel and an Allen-Bradley SLC 5/03, 5/04 or 5/05 CPU with DF-1 port.	<a href="#"><u>EA-SLC-232-CBL</u></a>	\$23.00
AutomationDirect communication cable, 15-pin male D-sub to 25-pin male D-sub, shielded, 3m/9.8ft cable length. For use with <b>C-more</b> or <b>C-more</b> Micro panel and an Allen-Bradley PLC-5 CPU with a DF1 port.	<a href="#"><u>EA-PLC5-232-CBL</u></a>	\$23.00
AutomationDirect communication cable, 15-pin male D-sub to 6-pin RJ45, shielded, 3m/9.8ft cable length. For use with <b>C-more</b> or <b>C-more</b> Micro panel and an Allen-Bradley SLC 5/01, 5/02 or 5/03 CPU with a DH485 port cable.	<a href="#"><u>EA-DH485-CBL</u></a>	\$22.50
AutomationDirect communication cable, 15-pin male D-sub to 15-pin male D-sub, shielded, 3m/9.8ft cable length. For use with <b>C-more</b> or <b>C-more</b> Micro and GE Fanuc Series 90/30 or 90/70 serial port.	<a href="#"><u>EA-90-30-CBL</u></a>	\$23.00
AutomationDirect communication cable, 15-pin male D-sub to 25-pin male D-sub, 3m/9.8ft cable length. For use with <b>C-more</b> or <b>C-more</b> Micro panel and a Mitsubishi FX Series CPU.	<a href="#"><u>EA-MITSU-CBL</u></a>	\$23.00
AutomationDirect cable, 15-pin male D-sub to 8-pin male mini DIN, shielded, 3m/9.8ft cable length. For use with <b>C-more</b> or <b>C-more</b> Micro panel and a Mitsubishi FX Series CPU.	<a href="#"><u>EA-MITSU-CBL-1</u></a>	\$23.00
AutomationDirect communication cable, 15-pin male D-sub to 25-pin male D-sub, shielded, 3m/9.8ft cable length. For use with <b>C-more</b> or <b>C-more</b> Micro panel and an Omron C200 or C500 CPU.	<a href="#"><u>EA-OMRON-CBL</u></a>	\$23.00

## Example Cables:



**EA-2CBL**



**EA-2CBL-1**



# C-more Computer Programming Connections

Using the C-more Programming Software [EA9-PGMSW](#) for project development, the HMI can be connected to a PC (personal computer) in one of several ways:

- Connect a USB Programming Cable such as (USB-CBL-AB15) from a USB port type A on the PC to the USB type B programming port on the C-more HMI. The USB connection is for direct connection only and does not support USB hubs.
- Connect the C-more HMI to a PC with a Cat5 Ethernet cable via an Ethernet switch. Multiple C-more HMIs can be programmed in this configuration.

Following are the minimum system requirements for running C-more Programming Software, p/n [EA9-PGMSW](#), on a PC:

- USB or Ethernet connection to HMI (cables sold separately).
- Windows operating system - see [automationdirect.com](http://automationdirect.com) for specific operating system requirements.



**NOTE: Regarding Ethernet access to a C-more HMI.**  
 If you intend to take advantage of the methods of remote access to the HMI, including the web server, PC remote access, FTP, iPhone or iPad app, you need to consider the security exposure in order to minimize the risks to your process and your C-more HMI.

Security measures may include password protection, changing the ports exposed on your network, including a VPN in your network, and other methods. Security should always be carefully evaluated for each installation.

## USB Programming Cable



### Part No. USB-CBL-ABxx

USB Programming Cables		
Part Number	Length	Price
USB-CBL-AB3	3 feet	\$9.00
USB-CBL-AB6	6 feet	\$11.75
USB-CBL-AB10	10 feet	\$27.00
USB-CBL-AB15	15 feet	\$31.00

## Stride® Ethernet Switch



Part No. [SE2-SW5U](#)  
 \$83.00

### USB Connectivity

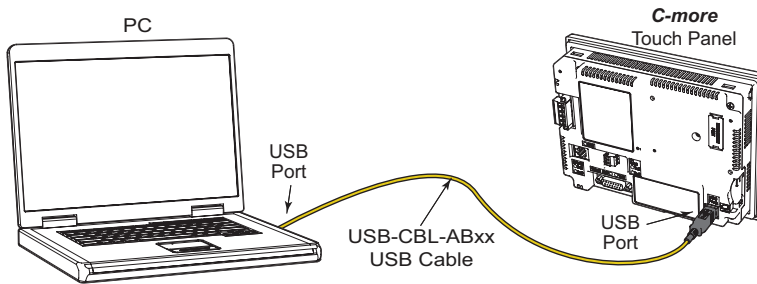

### Ethernet Connectivity via a Hub or Switch

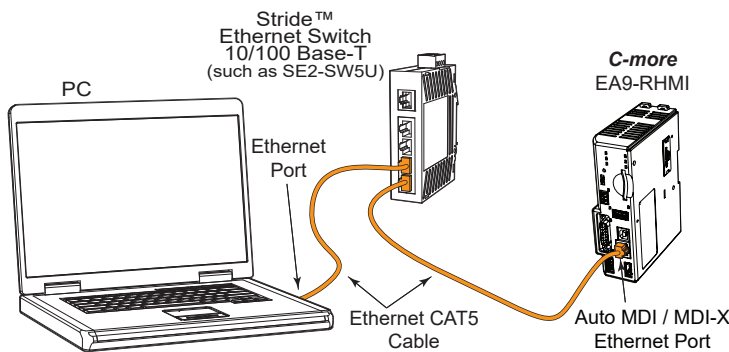

### Ethernet Direct Connection

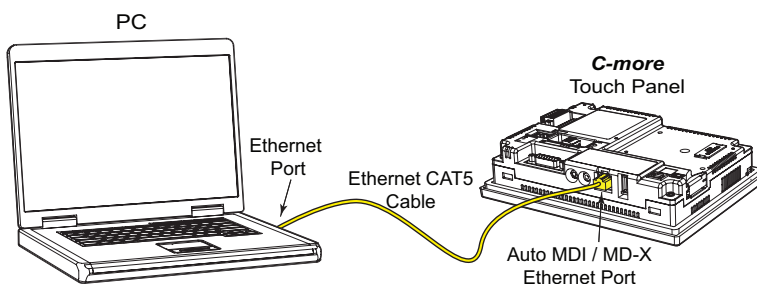

# C-more Accessories

## Accessories

C-more touch panels can be enhanced with the accessories below:

Part Number	Description	Price
<a href="#"><u>EA-AC</u></a>	<b>C-more</b> AC/DC power adapter, 24 VDC, 1.5A. For use with <b>C-more</b> EA7 and EA9 series touch panels.	\$80.00
<a href="#"><u>EA-6-COV2</u></a>	<b>C-more</b> screen protector, non-glare, 6in. Package of 3. For use with <b>C-more</b> and <b>C-more</b> Micro 6in HMIs.	\$40.50
<a href="#"><u>EA-7-COV2</u></a>	<b>C-more</b> screen protector, non-glare, 7in. Package of 3. For use with <b>C-more</b> 7in HMIs.	\$42.00
<a href="#"><u>EA-8-COV2</u></a>	<b>C-more</b> screen protector, non-glare, 8in. Package of 3. For use with <b>C-more</b> and <b>C-more</b> Micro 8in HMIs.	\$43.50
<a href="#"><u>EA-10-COV2</u></a>	<b>C-more</b> Micro screen protector, non-glare, 10in. Package of 3. For use with <b>C-more</b> EA9-T10CL and <b>C-more</b> Micro EA3-T10CL HMIs.	\$49.00
<a href="#"><u>EA-10W-COV2</u></a>	<b>C-more</b> screen protector, non-glare, 10in. Package of 3. For use with <b>C-more</b> EA9-T10WCL widescreen HMI.	\$49.00
<a href="#"><u>EA-12-COV2</u></a>	<b>C-more</b> screen protector, non-glare, 12in. Package of 3. For use with <b>C-more</b> 12in HMIs.	\$50.00
<a href="#"><u>EA-15-COV2</u></a>	<b>C-more</b> screen protector, non-glare, 15in. Package of 3. For use with <b>C-more</b> 15in HMIs.	\$59.00
<a href="#"><u>EA-ECOM</u></a>	<b>C-more</b> communication expansion module, (1) RJ45 10/100 Mbps Ethernet port. For use with <b>C-more</b> Micro EA3 series 6in, 8in and 10in panels and all <b>C-more</b> HMIs except -R models.	\$54.00
<a href="#"><u>EA-COMCON-3</u></a>	<b>C-more</b> DSUB port adapter, 15-pin male to 6-pole RS-422/485 terminal block, right angle cable entry. For use with <b>C-more</b> Micro EA1 series 4in and 6in HMIs, <b>C-more</b> Micro EA3 series 3in, 4in, and 6in HMIs, <b>C-more</b> EA9 6in and 7in HMIs.	\$45.50
<a href="#"><u>EA-COMCON-3A</u></a>	<b>C-more</b> Micro DSUB port adapter, 15-pin male to 6-pole RS-422/485 terminal block, straight cable entry. For use with <b>C-more</b> Micro EA1 series 3in with EA1-MG-SP1, <b>C-more</b> Micro EA3 series 8in and 10in HMIs, <b>C-more</b> EA9 8in, 10in, 12in and 15in HMIs.	\$22.50
<a href="#"><u>EA-SD-CARD</u></a>	<b>C-more</b> SD memory card, 2GB, industrial.	\$106.00
<a href="#"><u>USB-FLASH</u></a>	SanDisk USB Flash drive, 32GB.	\$21.50

## Accessory Locations

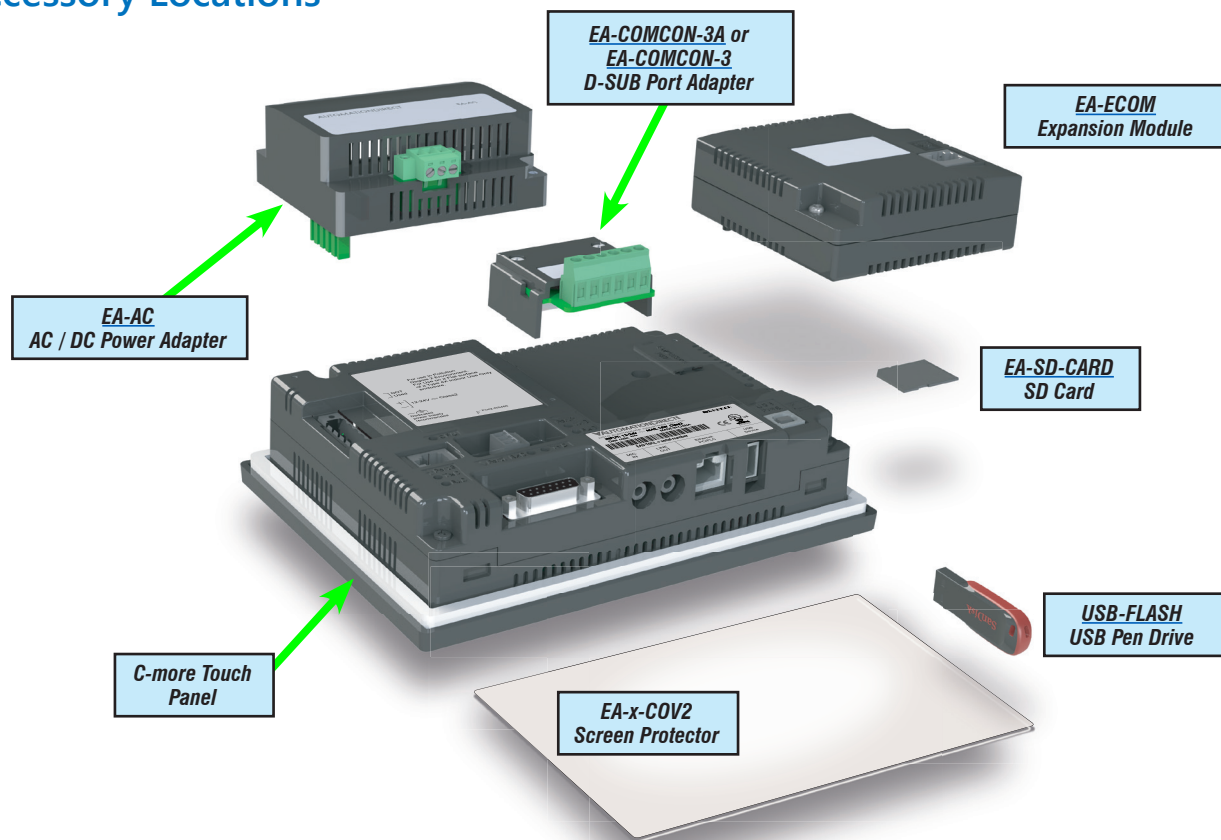

# C-more Accessories

## SD Card

### EA-SD-CARD



**\$106.00**

SD memory card for non-volatile storage, 2GB industrial grade. 85° C maximum operating temperature makes it suitable for data logging in industrial applications. Recommended for *C-more* EA9 series. The EA-SD-CARD utilizes SLC technology so it is the fastest option for writing and storing data. If logged data is saved to external memory, AutomationDirect recommends using an EA-SD-CARD.

SLC Flash memory utilized by EA-SD-CARD has the advantage of being the most accurate flash memory type when reading and writing data. SLC Flash has the longest lifespan of flash types and can operate in a broader temperature range than other types.

EA-SD-CARD with SLC Flash memory is recommended for industrial workloads that require heavy read / write cycles.

EA-SD-CARD Specifications	
<b>Operating Temperature</b>	0 to 70°C (32 to 158°F)
<b>Humidity</b>	20 to 85% (non-condensing)
<b>Capacity</b>	2GB
<b>Speed Modes</b>	High-Speed Normal-Speed
<b>Interface</b>	SD Memory Card Specification Ver. 3.0
<b>Speed Class</b>	Class 6

## USB Flash Drive

### USB-FLASH



**\$21.50**

USB flash drive for non-volatile storage, 32GB. Recommended for the *C-more* EA9 series touch panels.



# Communication Expansion Module

## EA-ECOM Ethernet Communication Module

The EA-ECOM communication module is compatible with EA3 series **C-more** Micro 6-inch, 8-inch and 10-inch panels and most **C-more** panels. It adds an Ethernet (RJ45) port for programming and PLC communications at 10/100 Mbps. **C-more** Micro Software and firmware version 4.0 or later is required. **C-more** Software and firmware version 6.50 or later is required.

Part No. **EA-ECOM** \$54.00



## Dimensions

Units: inches [mm]

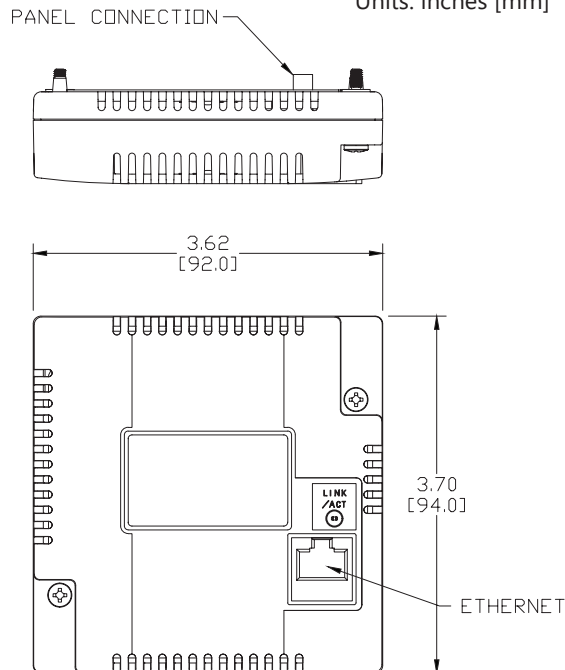

Ethernet Communication Interface Specifications	
<b>Standard Specification</b>	Conforms to IEEE802.3
<b>Communication Speed</b>	10/100 Base-T (Automatic Negotiation)
<b>Cable Specification</b>	Category 5
<b>Auto MDI / MDI-X</b>	Yes
<b>Connector Type</b>	RJ45

Communication Drivers	
C-more	C-more Micro
Supports all C-more Ethernet drivers	AutomationDirect Productivity Series Ethernet
	AutomationDirect Do-more / BRX Ethernet
	AutomationDirect CLICK Ethernet
	AutomationDirect ECOM Ethernet
	Modbus TCP/IP
	Allen-Bradley EtherNet/IP (Client) SLC5/05
	Allen-Bradley EtherNet/IP (Client) ENI Adapter
	Allen-Bradley EtherNet/IP (Client) MicroLogix 1100/1400
Allen-Bradley EtherNet/IP (Client) control/CompactLogix (SLC Mapping only)	



Link Status LED (Green)	
On	Ethernet Linked
Off	No Ethernet Comm.
Blinking Green	Comm. Activity







## EA-ECOM Specifications

Part Number	EA-ECOM
<b>Operating Temperature</b>	0 to 50 °C (32 to 122 °F) Maximum surrounding air temperature rating: 50 °C
<b>Storage Temperature</b>	-20 to +60 °C (-4 to +140 °F)
<b>Humidity</b>	5-95% RH (non-condensing)
<b>Environmental Air</b>	For use in pollution degree 2 environment
<b>Vibration</b>	IEC60068-2-6 (Test Fc), 5-9 Hz: 3.5 mm amplitude, 9-150 Hz: 1.0G, sweeping, at a rate of 1 octave/min. (±10%), 10 sweep cycles per axis on each of 3 mutually perpendicular axes
<b>Shock</b>	IEC60068-2-27 (Test Ea), 15 G peak, 11ms duration, three shocks in each direction per axis, on 3 mutually perpendicular axes (total of 18 shocks)
<b>Noise Immunity</b>	NEMA ICS3-304 RFI, (145 MHz, 440 MHz 10 W @ 10 cm) Impulse 1000 V @ 1 µs pulse
<b>Emission</b>	EN55011 Class A (Radiated RF emission)
<b>Enclosure (panel door installation)</b>	NEMA 250 type 4/4X indoor use only UL50 type 4X indoor use only IP-65 indoor use only (When mounted correctly)
<b>Agency Approvals</b>	CE (EN61131-2), UL508, CUL Canadian C22.2 To obtain the most current agency approval information, see the Agency Approval Checklist section on the specific part number's web page
<b>Mounting Torque</b>	50 oz-in [0.35 N-m]
<b>Weight</b>	0.23 lb [105g]

# C-more Replacement Parts

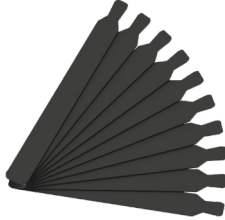
These replacement parts can be used to replace damaged, worn or lost C-more components.

## Replacement parts at a glance:

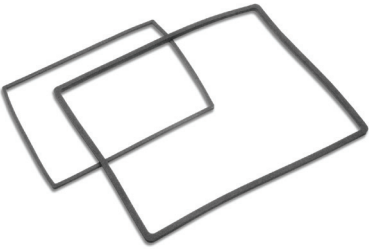
Part Number	Price		Description
<a href="#"><u>EA9-BRK</u></a>	\$28.50		<b>C-more</b> panel mounting brackets, replacement. Package of 8. For use with <b>C-more</b> EA9 series touch panels.
<a href="#"><u>EA9-LBL</u></a>	\$25.50		<b>C-more</b> blank label insert, replacement. Package of 10. For use with <b>C-more</b> EA9 series HMI front bezel.
<a href="#"><u>EA9-3TB</u></a>	\$9.75		<b>C-more</b> pluggable terminal block, replacement, 3-pole. Package of 2. For use with 3-wire RS485 communications port on <b>C-more</b> EA9 series panels.
<a href="#"><u>C0-4TB</u></a>	\$7.75		CLICK terminal blocks, replacement, 4-pole. Package of 2. For use with CLICK PLCs. and <b>C-more</b> EA9-RHMI.
<a href="#"><u>EA-DC-CON</u></a>	\$15.50		<b>C-more</b> DC 5-terminal power connector, replacement. For use with <b>C-more</b> EA7 and EA9 series touch panels.
<a href="#"><u>EA-AC-CON</u></a>	\$8.25		<b>C-more</b> AC 3-terminal power connector, replacement. For use with <b>C-more</b> AC adapter (p/n EA-AC).
<a href="#"><u>EA9-15-GSK</u></a>	\$26.50		<b>C-more</b> panel mounting gasket, replacement. For use with <b>C-more</b> EA9 series 15in HMIs.
<a href="#"><u>EA9-12-GSK</u></a>	\$21.50		<b>C-more</b> panel mounting gasket, replacement. For use with <b>C-more</b> EA9-T12CL 12in touch panel.
<a href="#"><u>EA9-10W-GSK</u></a>	\$20.50		<b>C-more</b> panel mounting gasket, replacement. For use with <b>C-more</b> EA9-T10WCL 10in HMI.
<a href="#"><u>EA9-10-GSK</u></a>	\$20.50		<b>C-more</b> panel mounting gasket, replacement. For use with <b>C-more</b> EA9-T10CL 10in HMI.
<a href="#"><u>EA9-8-GSK</u></a>	\$18.50		<b>C-more</b> panel mounting gasket, replacement. For use with <b>C-more</b> EA9-T8CL 8in touch panel.
<a href="#"><u>EA9-6-GSK</u></a>	\$16.50		<b>C-more</b> panel mounting gasket, replacement. For use with <b>C-more</b> EA9 series 6in and 7in touch panels.