

# C-more CM5 Series Touch Panels Overview

## C-more CM5 Series Touch Panels

- Analog touch screen
- 16.7-million colors LCD for enhanced graphics
- Screen resolutions up to 1920 X 1080 pixel
- FTP client/server
- E-mail client
- Web server
- MQTT client
- User configurable LED on the front of the panel
- Project simulation
- Up to (2) Ethernet ports
- Up to 3 serial ports, RS-232CC, RS422/485
- Up to (3) USB-A ports for logging, backups, and HID devices
- Programming via USB or Ethernet
- Thousands of built-in symbols and Windows fonts
- Network time server/client
- JPEG and JPG graphic object support
- Ethernet Remote Access
- Customizable label on the front of the panel
- 2-year warranty from date of purchase



Part Number	Price	Description	Drawing Link
<b><u><a href="#">CM5-T4W</a></u></b>	\$340.00	<b>C-more</b> CM5 series touch screen HMI, 4.3in color TFT LCD, analog resistive, widescreen, 480 x 272 pixel, WQVGA, LED backlight, (1) Ethernet, (2) serial and (2) USB ports and (1) memory card slot.	<a href="#">PDF</a>
<b><u><a href="#">CM5-T7W</a></u></b>	\$479.00	<b>C-more</b> CM5 series touch screen HMI, 7in color TFT LCD, analog resistive, widescreen, 800 x 480 pixel, WVGA, LED backlight, (1) Ethernet, (2) serial and (2) USB ports and (1) memory card slot.	<a href="#">PDF</a>
<b><u><a href="#">CM5-T10W</a></u></b>	\$769.00	<b>C-more</b> CM5 series touch screen HMI, 10.1in color TFT LCD, analog resistive, widescreen, 1024 x 600 pixel, WSVGA, LED backlight, (2) Ethernet, (3) serial and (4) USB ports and (1) memory card slot.	<a href="#">PDF</a>
<b><u><a href="#">CM5-T12W</a></u></b>	\$1,029.00	<b>C-more</b> CM5 series touch screen HMI, 12.1in color TFT LCD, analog resistive, widescreen, 1280 x 800 pixel, WXGA, LED backlight, (2) Ethernet, (3) serial and (4) USB ports and (1) memory card slot.	<a href="#">PDF</a>
<b><u><a href="#">CM5-T15W</a></u></b>	\$1,609.00	<b>C-more</b> CM5 series touch screen HMI, 15.6in color TFT LCD, analog resistive, widescreen, 1366 x 768 pixel, HD, LED backlight, (2) Ethernet, (3) serial and (4) USB ports and (1) memory card slot.	<a href="#">PDF</a>
<b><u><a href="#">CM5-T22W</a></u></b>	\$2,299.00	<b>C-more</b> CM5 series touch screen HMI, 21.5in color TFT LCD, analog resistive, widescreen, 1920 x 1080 pixel, FHD, LED backlight, (2) Ethernet, (3) serial and (4) USB ports and (1) memory card slot.	<a href="#">PDF</a>

**Please Note: \$US prices shown**  
**For current \$AUD visit [www.directautomation.com.au](http://www.directautomation.com.au)**

# C-more 12" TFT Color Touch Panel

## CM5-T12W

**C-more** CM5 series touch screen HMI, 12.1-inch color TFT LCD, 16.7M colors, 1280 x 800 pixel WXGA screen resolution, 1.6 GHz quad-core CPU, 12-24 VDC powered, NEMA 4/4X, IP65 (when mounted correctly; for indoor use only). Includes (2) Ethernet, (3) serial and (4) USB ports and (1) memory card slot. Compatible with [CM5-PGMSW](#) programming software v8.0 or later.

### Features

- 12.1" diagonal color TFT (thin film transistor) LCD display with 16.7M colors
- 1280 x 800 pixel resolution
- 280 nits display brightness
- 50,000 hour average backlight half-life
- Analog resistive (1024 X 1024) touch screen allowing unlimited touch areas
- (1) USB port B (program/download)
- (3) USB port A (USB device options)
- (2) Ethernet 10/100 Base-T ports (program/download & PLC communication)
- Ethernet Remote Access
- Serial PLC interface (RS-232C/422/485)
- Horizontal or portrait mounting
- One built-in SD memory card slot
- 12-24 VDC powered
- 43MB project memory
- Data logging
- 0 to 50°C [32 to 122°F] operating temperature range
- NEMA 4/4X, IP65 compliant when mounted correctly, indoor use only
- Slim design saves enclosure space
- Works with Remote HMI Mobile App



Function	Available
Ethernet	2 Ports
USB	4 Ports
SD Card	1 Slot
Audio Out	USB*
RJ12 (RS-232C)	Yes
DB15 (RS-232CC, RS-422, RS-485)	Yes
RS-485 3-wire	Yes

*\*with USB to Audio Adapter*

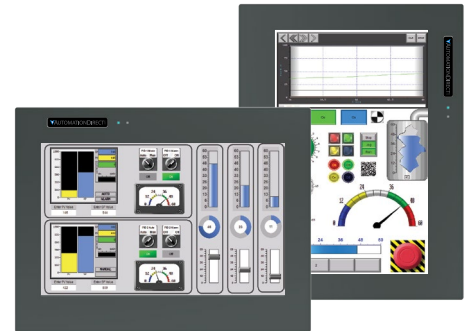

**\$1,029.00**

### Communication Ports

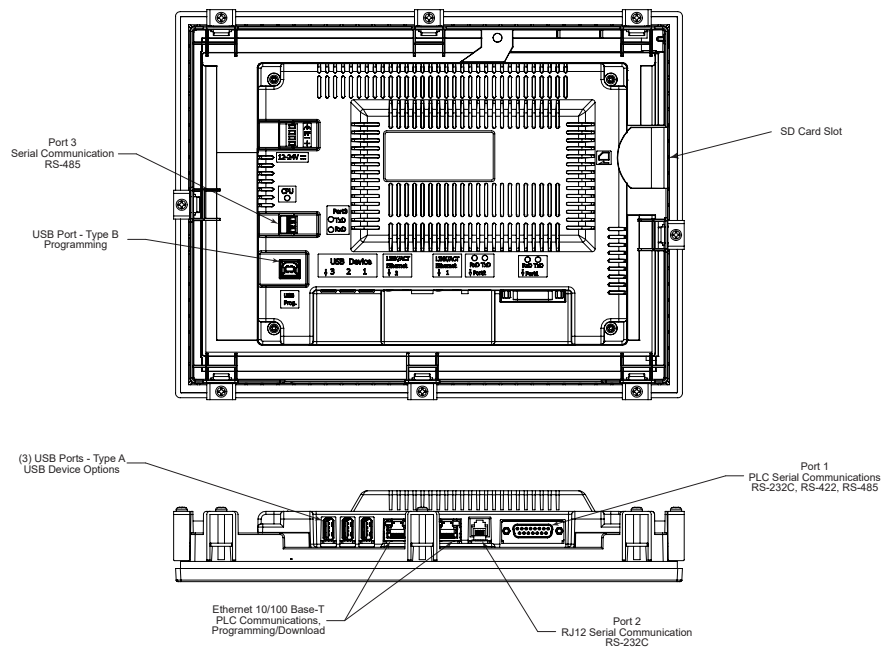

### Cutout Dimensions

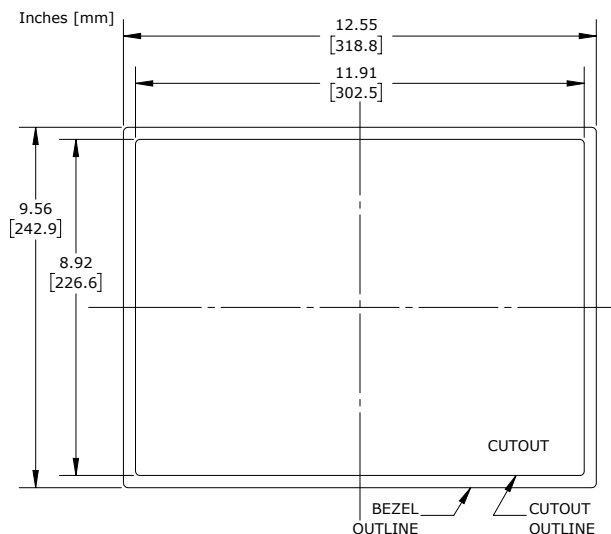













# C-more Selection Guide & Specifications

Specifications				
Model	10" TFT color	12" TFT color	15" TFT color	22" TFT color
Part Number	CM5-T10W	CM5-T12W	CM5-T15W	CM5-T22W
Price	\$769.00	\$1,029.00	\$1,609.00	\$2,299.00
Display Actual Size and Type	10.1" color TFT LCD	12.1" color TFT LCD	15.6" color TFT LCD	21.5" color TFT LCD
Display Viewing Area	222.72mm x 125.28mm [8.77" x 4.93"]	261.12mm x 163.2mm [10.28" x 6.43"]	344.232mm x 193.536mm [13.55" x 7.62"]	476.064mm x 267.786mm [18.74" x 10.54"]
Weight	2.29lbs	3.44lbs	5.51lbs	12.88lbs
Screen Pixel	1024 x 600 (WSVGA)	1280 x 800 (WXGA)	1366 x 768 (HD)	1920 x 1080 (FHD)
Display Brightness	315 nits (typ)	280 nits (typ)		
LCD Panel Dot Pitch	0.2175 x 0.2088 mm	0.2040mm x 0.2040 mm	0.252mm x 0.252 mm	0.24795mm x 0.24795 mm
Color Scale	16.7 M colors			
Backlight Average Lifetime*	50,000 hours @ 25°C			
Touch Panel Type**	Four-wire analog resistive, single touch			
Project Memory	43MB			
Number of Screens	Up to 999 screens – limited by project memory			
Realtime Clock	Realtime clock built into panel, backed up for 30 days at 25°C			
Calendar – Month / Day / Year	Yes - monthly deviation 60sec (Reference)			
Serial Port 1	15-pin D-sub female – RS232C, RS-422/485			
Serial Port 2	RJ-12 modular jack – RS-232CC			
Serial Port 3	3-wire terminal block – RS-485			
USB Port – Type B	USB 2.0 High speed (480 Mbps) Type B – Download/Program – Max. cable length 15-feet			
USB Port – Type A	(3) USB 2.0 High speed (480 Mbps) Type A – for USB device options – Max. cable length 15-feet – Bus Power – Less than 500mA each (less than 1500mA total) at 5VDC			
Ethernet Port	(2) 10/100 Base-T			
Ethernet Port - Expansion Module	N/A			
Audio Line Out	Only with USB to Audio adapter (Not included)			
Mic In (Future)	No			
SD Card Slot	1 slot supports max 2GB (SD), max 32GB (SDHC) max 2TB (SDXC)			
HDMI Video Out	N/A			
HDMI Supported Resolution	N/A			
Supply Power	10.2-26.4 VDC Class 2 or SELV (Safety Extra-Low Voltage) Circuit / Limited Energy Circuit (LIM), Reverse Polarity Protected			
Power Consumption	21.0 W 1.75 A @ 12VDC 0.88 A @ 24VDC	35.0 W 2.92 A @ 12VDC 1.46 A @ 24VDC	40.0 W 3.33 A @ 12VDC 1.67 A @ 24VDC	
Internal Fuse (non-replaceable)	12A			
Altitude	Up to 2000m (6562ft)			
Operating Temperature	0 to 50°C (32 to 122°F) Maximum surrounding air temperature rating: 50°C (122°F) IEC 60068-2-14 (Test Nb, Thermal Shock)			
Storage Temperature	-20 to +60°C (-4 to +140°F) IEC 60068-2-1 (Test Ab, Cold) IEC 60068-2-2 (Test Bb, Dry Heat) IEC 60068-2-14 (Test Na, Thermal Shock)			
Humidity	5-95% RH (non-condensing)			
Environment	For use in Pollution Degree 2 environment, no corrosive gases permitted			
Noise Immunity	(EN61131-2), EN61000-4-2 (ESD), EN61000-4-3 (RFI), EN61000-4-4 (FTB), EN61000-4-5 (Surge), EN61000-4-6 (Conducted) EN61000-4-8 (Power frequency magnetic field immunity) (Local Test) RFI, (145MHz, 440Mhz 10W @ 10cm), Impulse 1000V @ 1µs pulse			
Withstand Voltage	1000VAC, 1min. (FG to Power supply)			
Insulation Resistance	> 10M ohm @ 500VDC (FG to Power supply)			
Vibration	IEC60068-2-6 (Test Fc)			
Shock	IEC60068-2-27 (Test Ea)			
Emission	EN55011 Class A (Radiated RF emission)			
Enclosure	NEMA 250 type 4/4X indoor use only UL50 type 4X indoor use only; IP-65 indoor use only (When mounted correctly)			
Agency Approvals	UL61010, CE (EN61131-2), RoHS (2011/65/EU), CUL Canadian C22.2			

NOTES: \*The backlight average lifetime is defined as the average usage time it takes before the brightness becomes 50% of the initial brightness. The lifetime of the backlight depends on the ambient temperature. The lifetime will decrease under low or high temperature usage.

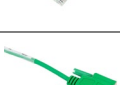
\*\*The touchscreen is designed to respond to a single touch. If it is touched at multiple points at the same time, an unexpected object may be activated.

# C-more Communication Cables

Cable Part Number	Product Photo	Cable Description	Price
<a href="#"><u>EA-2CBL</u></a>		AutomationDirect communication cable, 15-pin male D-sub to 6-pin RJ12, shielded, 9.8ft/3m cable length. For use with <b>C-more</b> or <b>C-more</b> Micro panel and AutomationDirect PLCs with RJ12 ports.	\$31.00
<a href="#"><u>EA-2CBL-1</u></a>		AutomationDirect communication cable, 15-pin male D-sub to 15-pin D-sub HD15 male, shielded, 3m/9.8ft cable length. For use with <b>C-more</b> or <b>C-more</b> Micro panel and a DL06, D2-250(-1), D2-260 or D2-262 (bottom port) CPU.	\$31.50
<a href="#"><u>EA-3CBL</u></a>		AutomationDirect communication cable, 15-pin male D-sub to 4-pin RJ11, shielded, 3m/9.8ft cable length. For use with <b>C-more</b> or <b>C-more</b> Micro panel and a D3-340 CPU top or bottom port.	\$31.00
<a href="#"><u>EA-4CBL-1</u></a>		AutomationDirect communication cable, 15-pin male D-sub to 15-pin male D-sub, shielded, 3m/9.8ft cable length. For use with <b>C-more</b> or <b>C-more</b> Micro panel and a DL405 (top port) CPU.	\$31.00
<a href="#"><u>EA-4CBL-2</u></a>		AutomationDirect communication cable, 15-pin male D-sub to 25-pin male D-sub, shielded, 3m/9.8ft cable length. For use with <b>C-more</b> or <b>C-more</b> Micro panel and a D2-DCM, D3-232-DCU, D3-350 (bottom port) or DL405 (bottom port) CPU.	\$32.00
<a href="#"><u>EA-MLOGIX-CBL</u></a>		AutomationDirect communication cable, 15-pin male D-sub to 8-pin male mini DIN, shielded, 3m/9.8ft cable length. For use with <b>C-more</b> or <b>C-more</b> Micro panel and an Allen-Bradley Micrologix CPU.	\$47.50
<a href="#"><u>EA-SLC-232-CBL</u></a>		AutomationDirect communication cable, 15-pin male D-sub to 9-pin female D-sub, shielded, 3m/9.8ft cable length. For use with <b>C-more</b> or <b>C-more</b> Micro panel and an Allen-Bradley SLC 5/03, 5/04 or 5/05 CPU with DF-1 port.	\$31.00
<a href="#"><u>EA-PLC5-232-CBL</u></a>		AutomationDirect communication cable, 15-pin male D-sub to 25-pin male D-sub, 3m/9.8ft cable length. For use with <b>C-more</b> or <b>C-more</b> Micro panel and an Allen-Bradley PLC-5 CPU with a DF1 port.	\$31.00
<a href="#"><u>EA-DH485-CBL</u></a>		AutomationDirect communication cable, 15-pin male D-sub to 6-pin RJ45, shielded, 3m/9.8ft cable length. For use with <b>C-more</b> or <b>C-more</b> Micro panel and an Allen-Bradley SLC 5/01, 5/02 or 5/03 CPU with a DH485 port cable.	\$30.50
<a href="#"><u>EA-90-30-CBL</u></a>		AutomationDirect communication cable, 15-pin male D-sub to 15-pin male D-sub, shielded, 3m/9.8ft cable length. For use with <b>C-more</b> or <b>C-more</b> Micro and GE Fanuc Series 90/30 or 90/70 serial port.	\$31.00
<a href="#"><u>EA-MITSU-CBL</u></a>		AutomationDirect communication cable, 15-pin male D-sub to 25-pin male D-sub, 3m/9.8ft cable length. For use with <b>C-more</b> or <b>C-more</b> Micro panel and a Mitsubishi FX Series CPU.	\$31.00
<a href="#"><u>EA-MITSU-CBL-1</u></a>		AutomationDirect communication cable, 15-pin male D-sub to 8-pin male mini DIN, shielded, 3m/9.8ft cable length. For use with <b>C-more</b> or <b>C-more</b> Micro panel and a Mitsubishi FX Series CPU.	\$31.00
<a href="#"><u>EA-OMRON-CBL</u></a>		AutomationDirect communication cable, 15-pin male D-sub to 25-pin male D-sub, shielded, 3m/9.8ft cable length. For use with <b>C-more</b> or <b>C-more</b> Micro panel and an Omron C200 or C500 CPU.	\$31.00

Note - Refer to the appropriate User Manual for specific cable pinouts, communication protocols and connection instructions.

# C-more Accessories

## Accessories

C-more touch panels can be enhanced with the accessories below:

Part Number	Price	Description
<a href="#"><u>HMI-4W-COV</u></a>	\$44.50	C-more screen protector, non-glare, 4.3in. Package of 3. For use with C-more 4in widescreen HMIs.
<a href="#"><u>HMI-7W-COV</u></a>	\$51.00	C-more screen protector, non-glare, 7in. Package of 3. For use with C-more 7in widescreen HMIs.
<a href="#"><u>HMI-10W-COV</u></a>	\$59.00	C-more screen protector, non-glare, 10.1in. Package of 3. For use with C-more 10in widescreen HMIs.
<a href="#"><u>HMI-12W-COV</u></a>	\$43.00	C-more screen protector, non-glare, 12.1in. Package of 3. For use with C-more CM5-T12W widescreen HMIs.
<a href="#"><u>HMI-15W-COV</u></a>	\$49.00	C-more screen protector, non-glare, 15.6in. Package of 3. For use with C-more CM5-T15W widescreen HMIs.
<a href="#"><u>HMI-22W-COV</u></a>	\$73.00	C-more screen protector, non-glare, 21.5in. Package of 3. For use with C-more CM5-T22W widescreen HMIs.
<a href="#"><u>EA-SD-CARD</u></a>	\$130.00	C-more industrial memory card, 2GB SD. For use with all products with SD memory card slot.
<a href="#"><u>MSD-SLC16G</u></a>	\$100.00	CLICK industrial memory card, 16GB microSD. For use with all products with microSD memory card slot.
<a href="#"><u>USB-FLASH</u></a>	\$25.50	SanDisk USB Flash drive, 32GB.
<a href="#"><u>EA-COMCON-3</u></a>	\$55.00	C-more DSUB port adapter, 15-pin male to 6-pole RS-422/485 terminal block, right angle cable entry. For use with C-more Micro EA1 series 4in and 6in HMIs, C-more Micro EA3 series 3in, 4in, and 6in HMIs, C-more EA9 6in and 7in HMIs.
<a href="#"><u>EA-COMCON-3A</u></a>	\$30.50	C-more Micro DSUB port adapter, 15-pin male to 6-pole RS-422/485 terminal block, straight cable entry. For use with C-more Micro EA1 series 3in with EA1-MG-SP1, C-more Micro EA3 series 8in and 10in HMIs, C-more EA9 8in, 10in, 12in and 15in HMIs.

## Accessory Locations

### CM5-T4W

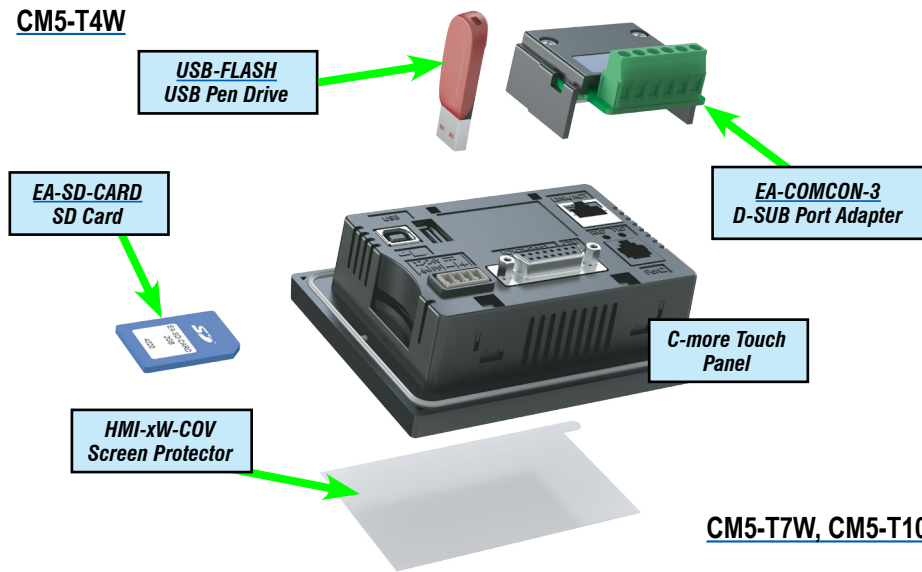

### CM5-T7W, CM5-T10W, CM5-T12W, CM5-T15W, CM5-T22W

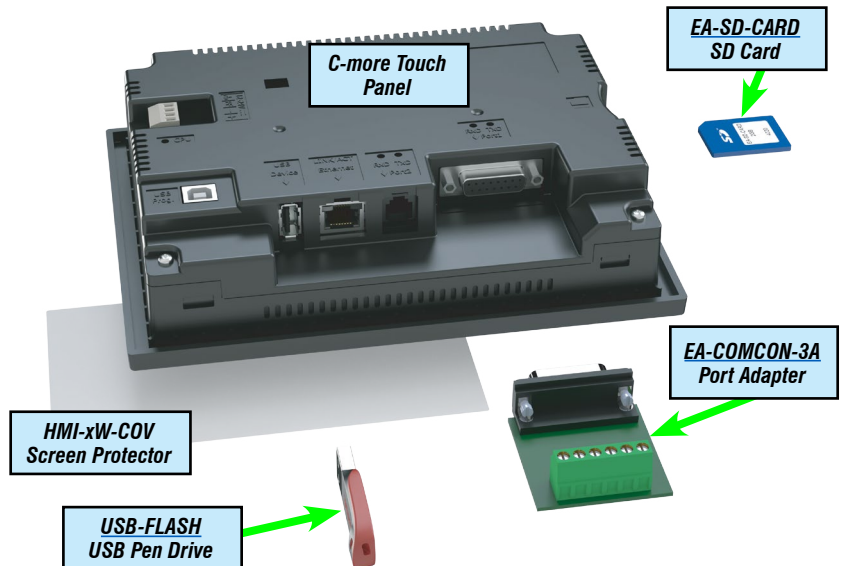

# C-more Accessories

## SD Cards

### EA-SD-CARD



**\$130.00**

### MSD-SLC16G

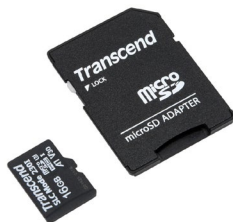

**\$100.00**

SD memory cards for non-volatile storage, 2GB or 16GB industrial grade. High operating temperature make [EA-SD-CARD](#) and [MSD-SLC16G](#) suitable for data logging in industrial applications. These cards are recommended for **C-more** CM5 series.

[EA-SD-CARD](#) and [MSD-SLC16G](#) utilize SLC technology so they are the fastest and most reliable option for writing and storing data. If logged data is saved to external memory, AutomationDirect recommends using [EA-SD-CARD](#) and [MSD-SLC16G](#). SLC Flash has the longest lifespan of flash types and can operate in a broader temperature range than other types.

[EA-SD-CARD](#) and [MSD-SLC16G](#) with SLC Flash memory is recommended for industrial workloads that require heavy read / write cycles.

SD Card Specifications		
Part Number	<a href="#">EA-SD-CARD</a>	<a href="#">MSD-SLC16G</a>
Operating Temperature	0 to 70°C (32 to 158°F)	-40 to 85°C (-40 to 185°F)
Humidity	20 to 85% (non-condensing)	0 to 95% (non-condensing)
Capacity	2GB	16GB
Flash Type	SLC	3D NAND Flash (SLC Mode)
Speed Modes	High-Speed Normal-Speed	UHS-I
Interface	SD Memory Card Specification Ver. 3.0	SD Memory Card Specification Ver. 5.1
Speed Class	Class 6	Class 10

## USB Flash Drive

### USB-FLASH



**\$25.50**

[USB-FLASH](#) sold by AutomationDirect has been tested with **C-more** HMIs and is Hi-Speed USB 2.0 certified. The [MSD-SLC16G](#) is the best option for logging data, but the [USB-FLASH](#) is a high-quality flash drive perfect for transferring log files, capturing screens, backing up and restoring projects and storing images for the Image Viewer object.

# C-more Accessories

## D-SUB 15-pin to Terminal Block Adapter - Right Angle

The EA-COMCON-3 adapter plugs into the 15-pin serial port on the rear of a panel to allow wire terminal connections for an RS-422/RS-485 communication cable. Compatible with **C-more** CM5-T4W. EA-COMCON-3 is UL Recognized.

Part No.  
**EA-COMCON-3**



\$55.00

### Dimensions

Units: inches [mm]

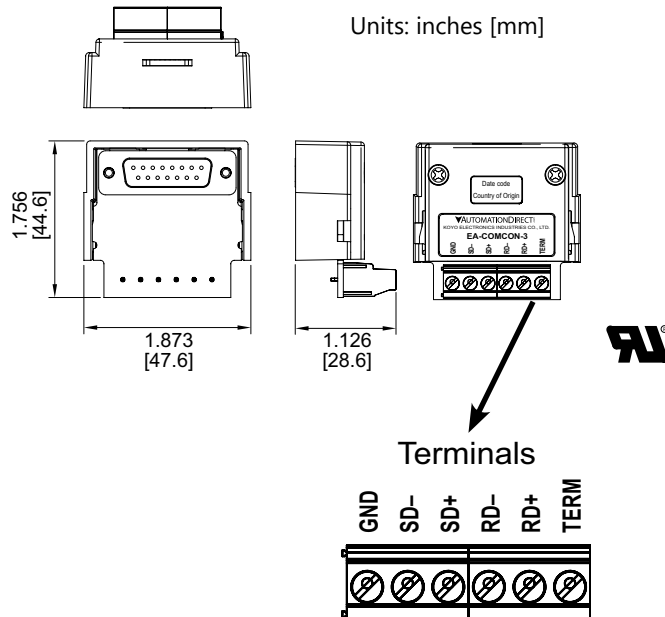

## D-SUB 15-pin to Terminal Block Adapter - Straight Through

The EA-COMCON-3A adapter plugs into the 15-pin serial port on the rear of a panel to allow wire terminal connections for an RS-422/RS-485 communication cable. Compatible with **C-more** CM5-T7W, CM5-T10W, CM5-T12W, CM5-T15W, and CM5-T22W. The EA-COMCON-3A is not UL recognized or listed.

Part No.  
**EA-COMCON-3A**



\$30.50

### Dimensions

Units: inches [mm]

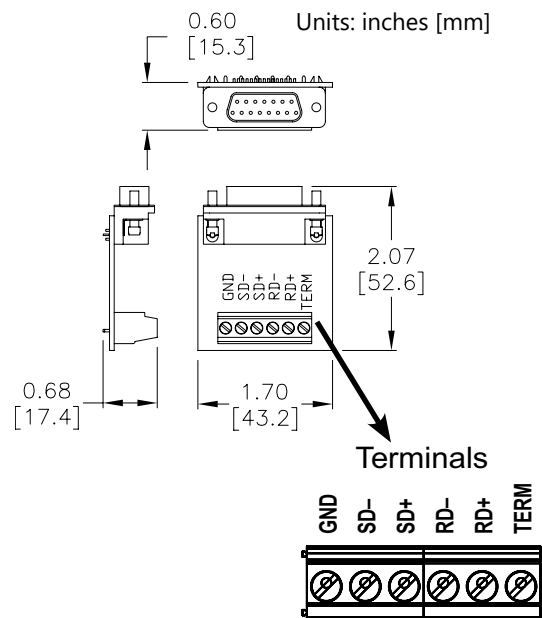

EA-COMCON-3(A) Wiring Specs	
Wire Size	Screw Torque
14-24 AWG	4.4 lb-in [0.5 Nm]

# C-more Accessories

## Non-glare Screen Covers (in packages of 3)

The non-glare screen covers are protective overlays used to protect the touch screen while helping to reduce the glare from external light sources.

**Part Numbers:** HMI-4W-COV, HMI-7W-COV, HMI-10W-COV, HMI-12W-COV, HMI-15W-COV, HMI-22W-COV

### Dimensions

Units: inches [mm]

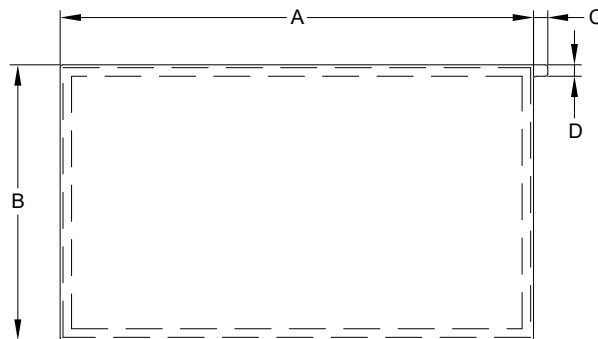
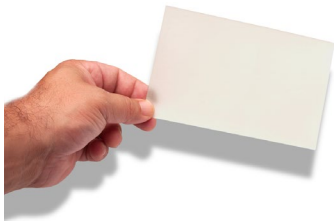

<u>HMI-4W-COV</u>	\$44.50
<u>HMI-7W-COV</u>	\$51.00
<u>HMI-10W-COV</u>	\$59.00
<u>HMI-12W-COV</u>	\$43.00
<u>HMI-15W-COV</u>	\$49.00
<u>HMI-22W-COV</u>	\$73.00

Non-glare Screen Covers Dimensions (inches [mm])				
Part Number	A	B	C	D
<u>HMI-4W-COV</u>	4.15 [105.5]	2.52 [64.0]	0.20 [5.0]	0.16 [4.0]
<u>HMI-7W-COV</u>	6.40 [162.6]	4.00 [101.5]		
<u>HMI-10W-COV</u>	9.23 [234.5]	5.38 [136.7]		
<u>HMI-12W-COV</u>	10.70 [271.9]	6.85 [173.9]		
<u>HMI-15W-COV</u>	14.13 [358.9]	8.19 [208.2]		
<u>HMI-22W-COV</u>	19.33 [491.0]	11.13 [282.6]		

## Installation

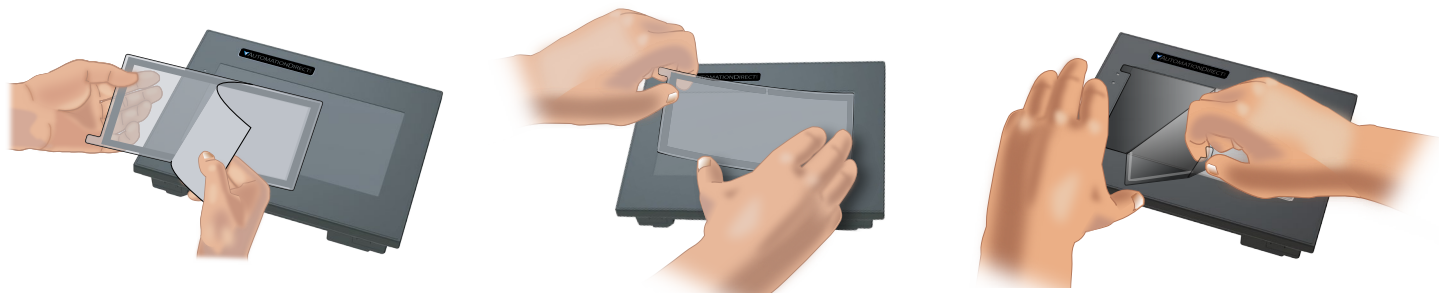





**NOTE:** The Protective Cover ships with a thin protective sheet on the face of the cover that needs to be carefully removed. If your panel is not clear, the protective sheet may not have been removed.



# C-more Replacement Parts

These replacement parts can be used to replace damaged, worn or lost **C-more** components.

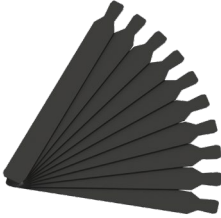
## Replacement parts at a glance:

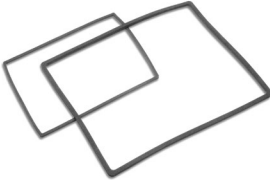
Part Number	Price		Description
<a href="#"><u>HMI-BRK-1</u></a>	\$23.00		<b>C-more</b> panel mounting brackets, replacement. Package of 2. For use with <b>C-more</b> CM5-T4W 4in HMI.
<a href="#"><u>HMI-BRK-2</u></a>	\$35.00		<b>C-more</b> panel mounting brackets, replacement. Package of 8. For use with <b>C-more</b> CM5 series 7in, 10in, 12in, 15in and 22in HMIs.
<a href="#"><u>HMI-LOGO-LBL</u></a>	\$31.00		<b>C-more</b> blank label insert, replacement. Package of 10. For use with <b>C-more</b> CM5 series HMI front bezel.
<a href="#"><u>HMI-3TB</u></a>	\$12.50		<b>C-more</b> pluggable terminal block, replacement, 3-pole. Package of 2. For use with 3-wire RS-485 communications port on <b>C-more</b> CM5 series HMIs.
<a href="#"><u>C0-4TB</u></a>	\$9.50		CLICK terminal blocks, replacement, 4-pole. Package of 2. For use with CLICK PLCs.
<a href="#"><u>HMI-4W-GSK</u></a>	\$11.50		<b>C-more</b> panel mounting gasket, replacement. For use with <b>C-more</b> CM5-T4W 4in HMI.
<a href="#"><u>HMI-7W-GSK</u></a>	\$27.00		<b>C-more</b> panel mounting gasket, replacement. For use with <b>C-more</b> CM5-T7W 7in HMI.
<a href="#"><u>HMI-10W-GSK</u></a>	\$28.00		<b>C-more</b> panel mounting gasket, replacement. For use with <b>C-more</b> CM5-T10W 10in HMI.
<a href="#"><u>HMI-12W-GSK</u></a>	\$29.00		<b>C-more</b> panel mounting gasket, replacement. For use with <b>C-more</b> CM5-T12W 12in HMI.
<a href="#"><u>HMI-15W-GSK</u></a>	\$30.00		<b>C-more</b> panel mounting gasket, replacement. For use with <b>C-more</b> CM5-T15W 15in HMI.
<a href="#"><u>HMI-22W-GSK</u></a>	\$36.00		<b>C-more</b> panel mounting gasket, replacement. For use with <b>C-more</b> CM5-T22W 22in HMI.

# C-more Programming Software

## CM5-PGMSW - FREE Download!

**C-more** Programming Software can be downloaded at no charge or a USB version may be purchased by ordering CM5-PGMSW. The software requires a USB port or Ethernet connection\* on your PC to connect to the **C-more** panel. Software Help Files are included in the download. This software programs all the **C-more** panels.

## CM5-PGMSW USB Flash Drive



\$12.50

## Software Features

- Over 50 objects including 16 pen trends, switches, PID trend faceplate, PID bar graph
- Event Manager allows for logging and notifications
- Language support for objects in German, French, Italian, Spanish, Chinese and Japanese Characters
- Project simulator
- Bitmap animation
- E-mail messaging
- Built-in FTP server / Web server
- Popup windows
- Data logging to USB/SD flash drive
- USB 2.0 Type B port for programming
- Historical alarms with time and date stamp along with alarm frequency reporting
- Supports simultaneous communication to multiple brands of PLC/PACs
- Mouse and keyboard support within the project
- Remote HMI feature with smart phone / tablet / PC
- 2 year warranty and a 30-day money-back policy

## Computer System Requirements

CM5-PGMSW will run on PCs that meet the following requirements:

- Windows OS: 8: 32 & 64 bit, 8.1: 32 & 64 bit, 10, 11
- 2GB of available memory
- 1GB hard drive space
- Available Ethernet or USB port