

# BX 10/10E MPUs

**BX-DM1E-10AR3-D \$389.00**

**BRX MPU with Do-more! DM1 technology**

- 24VDC required; serial port; Ethernet port; microSD slot
- Discrete input: 6-point, AC
- Analog input: 1-channel, current / voltage
- Discrete output: 4-point, relay
- Analog output: 1-channel, current / voltage

CPU Specifications	
Program Memory Type	FLASH memory
User Data Memory Type	Battery-backed RAM, user configurable
Serial Port	RS-232/485 3-Pin, Software selectable
Ethernet Port	RJ-45, 10/100 Mbps
Pluggable Option Module	RS-232, RS-485, Ethernet 10/100 BASE-T (1 Mbps throughput max), USB 2.0 Type B
Data Logging/File Management	microSD card slot (32G max)
Expansion Modules	2 expansion modules max
Real Time Clock Accuracy	±2.6 s per day typical at 25°C ±8s per day max at 60°C
Programming Software	Do-more! Designer – Ver. 2.0 or higher
Programming Cable Options	BX-PGM-CBL
MPU Weight	181g (6.4 oz)

Discrete Input Specifications	
Input Type	AC
Total Inputs per Module	6 Standard
Commons	2 (3 points/common) Isolated
Nominal Voltage Rating	120–240 VAC
Input Voltage Range	85–264 VAC
Maximum Voltage	264 VAC RMS
AC Frequency	47–63 Hz
Input Current (typical)	9mA @ 120VAC, 13mA @ 220VAC
Input Impedance	15kΩ
ON Voltage Level	> 85 VAC
OFF Voltage Level	< 40 VAC
Status Indicators	Logic Side, Green

## I/O Wiring

### Discrete Input Wiring

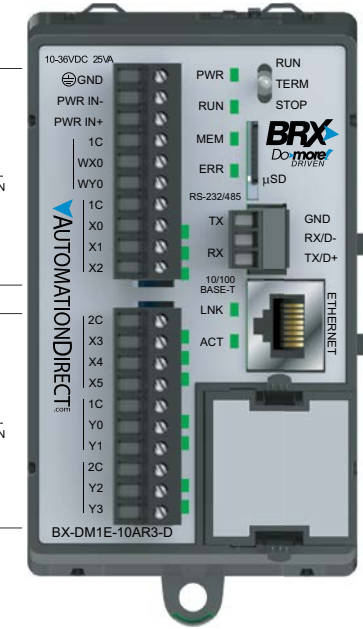
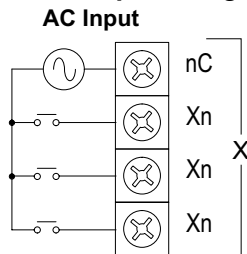

**I/O Terminal Blocks sold separately.**  
(See Removable Terminal Block Specifications Table on BX 10/10E MPU Accessories page.)

Discrete Output Specifications	
Output Type	Relay Form A (SPST)
Total Outputs per Module	4 Relay
Commons	2 (2 points/common) Isolated
Maximum current per common	4A
Nominal Voltage Ratings	12–48 VDC, 24–240 VAC
Operating Voltage Range	5–60 VDC, 5–264 VAC
Maximum Voltage	60VDC, 264VAC
Minimum Output Current	0.1 mA @ 24VAC/DC
Maximum Output Current	2A
Maximum Leakage Current	1uA (DC) 300uA (AC) due to RC Snubber Circuit
Maximum Switching Frequency	10Hz
Status Indicators	Logic Side, Green

### Discrete Output Wiring

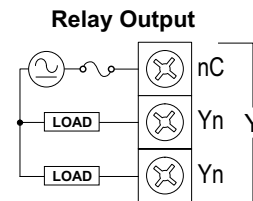

### Supply Power Wiring

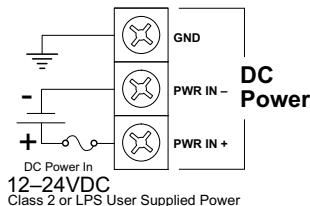

# BX 10/10E MPUs

Analog Input Specifications	
<b>Inputs per Module</b>	1
<b>Input Voltage Range</b>	Software Selectable ±10V, ±5V, 0–10 V, 0–5 V
<b>Input Current Range</b>	Software Selectable ±20mA, 4–20 mA
<b>Resolution</b>	16 bit @ ± 10V, ± 20mA
<b>Conversion Time</b>	1.2 ms
<b>Input Impedance</b>	100kΩ
<b>Input Impedance Voltage Modes</b>	
<b>Input Impedance Current Modes</b>	249Ω

Analog Output Specifications	
<b>Outputs per Module</b>	1
<b>Output Voltage Range</b>	Software Selectable ±10V, ±5V, 0–10 V, 0–5 V
<b>Minimum Voltage Load Impedance</b>	1kΩ
<b>Output Current Range</b>	Software Selectable ±20mA, 4–20 mA
<b>Maximum Current Load Impedance</b>	500Ω
<b>Conversion Time</b>	< 1ms
<b>Resolution</b>	16 bit @ ± 10V, ± 20mA

### Analog Current Sinking Input Circuits

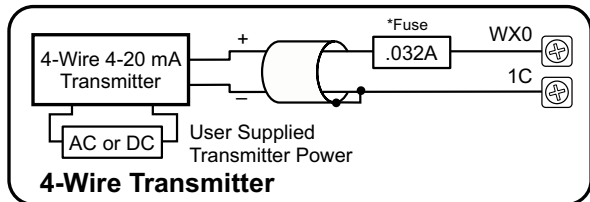
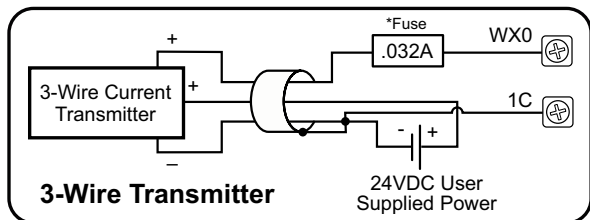
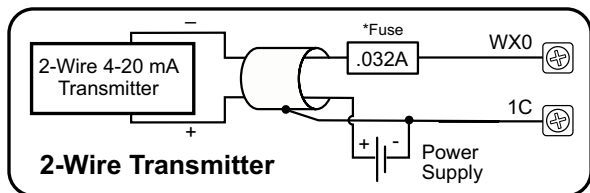

\*NOTE: An Edison S500-32-R 0.032A fast-acting fuse is recommended for all analog voltage inputs, analog outputs, and current loops.

### Analog Voltage Input Circuits

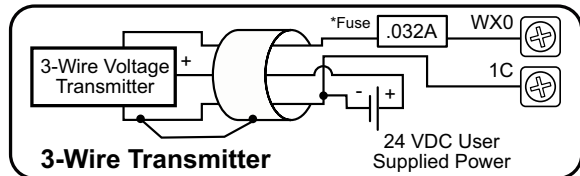
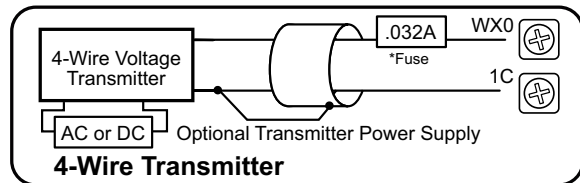

### Analog Output Wiring

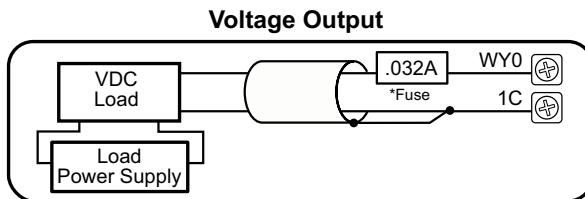
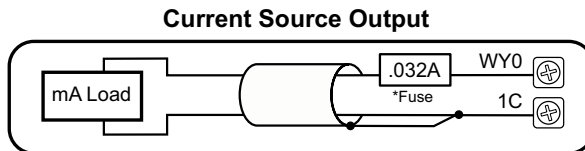

# BRX Micro PLC Overview

The BRX platform enables you to choose from various communications ports. All BRX MPU models have a built-in RS232C/485 (software-selectable) serial port. However, an RJ45 Ethernet port (10/100 Mbps) is provided on select units. With support for EtherNet/IP, Modbus TCP, Modbus RTU, ASCII, K-sequence (DirectLOGIC users) and custom protocols, the BRX MPU platform provides supreme

versatility for any application. BRX hardware is built to last and is engineered, assembled and supported right here in America; designed and fabricated by industrial automation veterans with hardware facilities in Tennessee and Florida. The compact modular architecture results in an outstanding controller package, with high performance, a small footprint, at a very low cost. The BRX

platform has built-in high-speed I/O, motion control, on-board analog I/O, and many other features that enable you to build the ideal controller for your application. Below is a quick look at some of the standard features available on the BRX Platform.

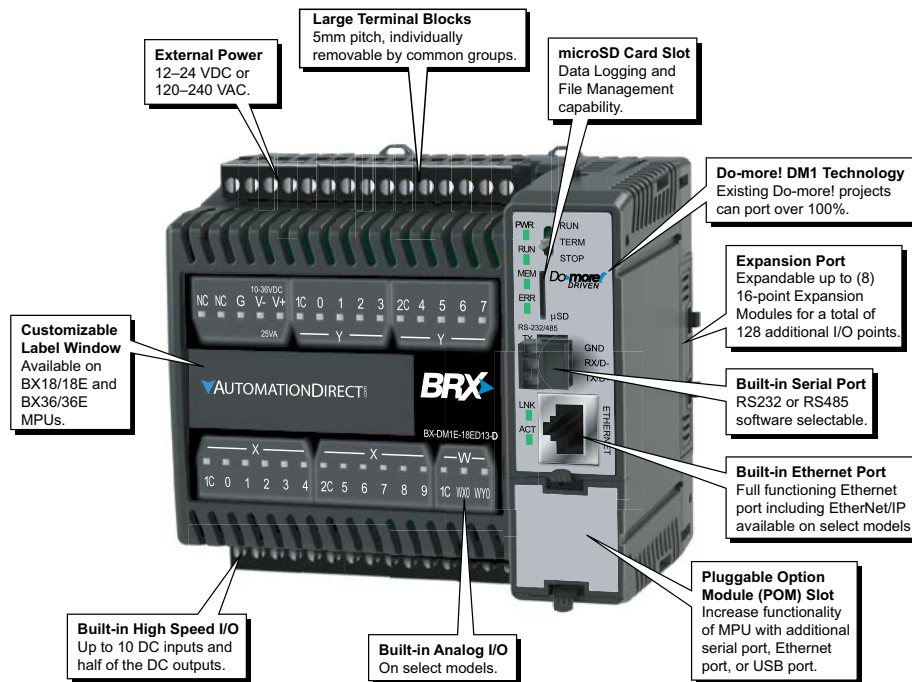

General Specifications	
<b>Operating Temperature</b>	0° to 60°C [32° to 140°F]
<b>Storage Temperature</b>	-20° to 85°C [-4° to 185°F]
<b>Humidity</b>	5 to 95% (non-condensing)
<b>Environmental Air</b>	No corrosive gases permitted
<b>Vibration</b>	IEC60068-2-6 (Test Fc)
<b>Shock</b>	IEC60068-2-27 (Test Ea)
<b>Enclosure Type</b>	Open Equipment
<b>Agency Approvals</b>	UL61010-2 - UL File # E185989 Canada and USA CE Compliant EN61131-2*
<b>Noise Immunity</b>	NEMA ICS3-304
<b>EU Directive</b>	See the "EU Directive" topic in the Help File

\*Meets EMC and Safety requirements. See the D.O.C. for details.



## 2 Year Warranty

All BRX PLCs are covered under a 2- year warranty.

# BRX Micro PLC Overview

Built-in RS-232/485 Port Specifications	
<b>Port Name *</b>	RS-232/RS-485 Serial Port
<b>Description</b>	Non-isolated serial port that can communicate via RS-232 or RS-485 (software selectable). Includes ESD protection and built-in surge protection.
<b>Supported Protocols</b>	Do-more Protocol (Default) Modbus RTU (Master & Slave) K-Sequence (Slave) ASCII (In & Out) Programming and Monitoring
<b>Data Rates</b>	1200, 2400, 4800, 9600, 19200, 38400, 57600, and 115200
<b>Default Settings</b>	RS-232, 115200 bps, No Parity, 8 Data Bits, 1 Stop Bit, Station #1
<b>Port Type</b>	3-pin terminal strip 3.5 mm pitch
<b>Port Status LED</b>	Green LED is illuminated when active for TXD and RXD
<b>RS-485 Station Addresses</b>	1-247
<b>Cable Recommendations</b>	RS-232 use L19772-XXX from AutomationDirect.com RS-485 use L19827-XXX from AutomationDirect.com
<b>Replacement Connector</b>	ADC Part # <a href="#">BX-RTB03S</a>

Removable connector included.

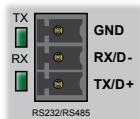

Pinout	RS232	RS485
1	GND	GND
2	RXD	D-
3	TXD	D+

\*When using RS-485 a termination resistor is available and is software selectable.

CPU Status Indicators		
Indicator	Status	Description
<b>PWR</b>	OFF	Base Power OFF
	Green	Base Power ON
	Yellow	Low Battery
<b>RUN</b>	OFF	CPU is in STOP Mode
	Green	CPU is in RUN Mode
	Yellow	Forces are Active
<b>MEM</b>	OFF	No ROM Activity, No SD Card
	Yellow	ROM Activity (Flash or SD Card)
	Green	SD Card Installed and Mounted
	Red	SD Card Installed and Not Mounted
<b>ERR</b>	OFF	CPU is functioning normally
	Red	CPU Fatal Hardware Error or Software Watchdog Error

CPU Mode Switch	
<b>RUN</b>	CPU is forced into RUN Mode if no errors are encountered.
<b>TERM</b>	RUN, PROGRAM and DEBUG modes are available. In this position, the mode of operation can be changed through the Do-more! Designer Software.
<b>STOP</b>	CPU is forced into STOP Mode.



microSD Specifications				
<b>Port Name</b>	microSD Card Slot			
<b>Description</b>	Standard microSD socket for data logging or file read/write			
<b>Maximum Card Capacity</b>	32GB			
<b>Transfer Rate (ADATA microSDHC Class 4 memory card)</b>	Mbps	Minimum	Typical	Maximum
	Read	14.3	14.4	14.6
Write	4.8	4.9	5.1	
<b>Port Status LED</b>	Green LED is illuminated when card is inserted/detected			
<b>Optional microSD Card</b>	ADC Part # <a href="#">MICSD-16G</a>			



Pin	SD
1	DAT2
2	CD/DAT3
3	CMD
4	VDD
5	CLK
6	VSS
7	DAT0
8	DAT1

AC Power Supply Specifications	
<b>Nominal Voltage Rating</b>	120–240 VAC
<b>Input Voltage Range (Tolerance)</b>	85–264 VAC
<b>Rated Operating Frequency</b>	47–63 Hz
<b>Maximum Input Power</b>	40VA
<b>Cold Start Inrush Current</b>	1.5A, 2ms
<b>Maximum Inrush Current (Hot Start)</b>	1.5A, 2ms
<b>Internal Input Fuse Protection</b>	Micro fuse 250V, 2A Non-replaceable
<b>Isolated User 24VDC Output</b>	24VDC @ 0.3 A max, <1V P-P Ripple, Integrated self-resetting short circuit protection
<b>Voltage Withstand (dielectric)</b>	1500VAC Power Inputs to Ground applied for 1 minute
	1500VAC Ground to 24VDC applied for 1 minute

DC Power Supply Specifications	
<b>Nominal Voltage Rating</b>	12–24 VDC
<b>Input Voltage Range (Tolerance)</b>	10-36 VDC
<b>Maximum Input Voltage Ripple</b>	<± 10%
<b>Maximum Input Power</b>	30W (14W for BX 10/10E MPUs)
<b>Cold Start Inrush Current</b>	5A, 2ms
<b>Maximum Inrush Current (Hot Start)</b>	5A, 2ms
<b>Internal Input Protection</b>	Reverse Polarity Protection and Undervoltage
<b>Voltage Withstand (dielectric)</b>	1500VAC Power Inputs to Ground applied for 1 minute

# BX 10E MPUs

Please note: \$US prices shown

For current \$AUD visit [www.directautomation.com.au](http://www.directautomation.com.au)

## 10 Discrete I/O Points: 6 Inputs, 4 Outputs

### Features

- All units are externally powered by a nominal 12–24 VDC
- All units have a built-in RJ-45 Ethernet port, 10/100 Mbps
- Models with DC inputs have:
  - 6 high speed inputs up to 250kHz
  - can accept 12–24 nominal voltages AC or DC
  - can be wired as sinking or sourcing
- Models with AC inputs can accept 120–240 nominal voltages
- All units have 1 analog input (current/voltage software selectable)
- Output types available are DC sinking, DC sourcing, and relay
- Models with DC outputs have 2 high speed outputs up to 250kHz
- Support for 2 additional expansion modules
- Onboard RS-232/485 port with removable 3-Pin connector
- microSD card slot



**BX 10E Micro PLC Unit (MPU)**  
(Built-in Analog and Ethernet port)

BX 10E MPUs							
Part Number	Price	External Power	Discrete Inputs	Discrete Output	Analog		Expansion Modules
					Input	Output	
<a href="#"><u>BX-DM1E-10ED13-D</u></a>	\$382.00	12–24 VDC	6 High-Speed, Sinking or Sourcing	2 High-Speed 2 Standard DC Sinking	1 Current or Voltage	1 Current or Voltage	2
<a href="#"><u>BX-DM1E-10ED23-D</u></a>	\$381.00			2 High-Speed 2 Standard DC Sourcing			
<a href="#"><u>BX-DM1E-10ER3-D</u></a>	\$397.00			4 Form A Relay			
<a href="#"><u>BX-DM1E-10AR3-D</u></a>	\$389.00		6 Standard AC				

<b>Port Name</b>	ETHERNET	
<b>Description</b>	Standard transformer isolated Ethernet port with built-in surge protection.	
<b>Transfer Rate</b>	10 Mbps (Yellow LED) and 100 Mbps (Green LED)	
<b>Port Status LED</b>	LED is solid when network LINK is established. LED flashes when port is active (ACT).	
<b>Supported Protocols</b>	Port:	
	Do-more! Protocol	28784, UDP
	Modbus TCP	502, TCP
	TCP/IP	User-defined, TCP
	Custom Protocol	User-defined
	SNTP (Time Server)	123, TCP
	SMTP (Email)	25, TCP
	MQTT	1883, TCP
	MQTTS	8883, TCP
	HTTP	80, TCP
	HTTPS	443, TCP
	FTP (Client)	21, TCP
	EtherNet/IP: Explicit (Client, Server), Implicit (Server)	44818, TCP
	DHCP	67,68, UCP
Ethernet Remote I/O programming and monitoring	28784, UDP	
<b>Cable Recommendation</b>	C5E-STxxx-xx from AutomationDirect.com	
<b>Port Type</b>	RJ45, Category 5, 10/100 BASE-T, Auto Crossover	

# BX 10/10E MPUs

## Dimensions, inches[mm]

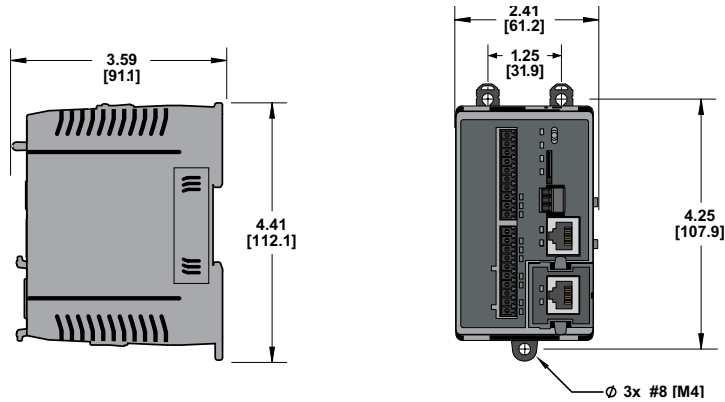

## Clearances and Mounting Restrictions

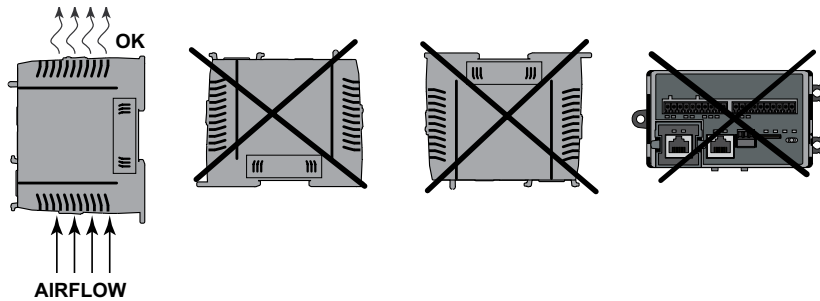
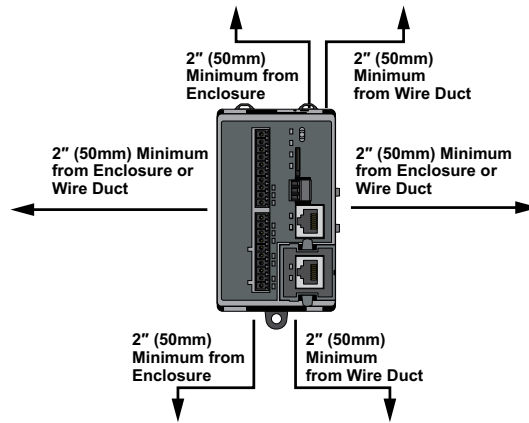

# BX 10/10E MPUs Accessories

## BX 10/10E MPU Wiring Termination Selection

The BX 10/10E MPUs ship without wiring terminals. This enables you to select the termination solution that best fits your

application. Several wiring options are available, including removable screw terminal connectors,

removable spring clamp terminal connectors and prewired **ZIP**Link cable solutions.

## Terminal Block Connectors

The terminal block connectors are provided in kits and can be easily ordered as a single part number to receive all the terminal block connectors needed. Each

kit for the BX 10/10E MPU comes with two (2) 10-pin 3.8 mm terminal blocks. On the BX 10/10E MPUs the terminals are organized into groups consisting of

3 inputs with an isolated common and 2 outputs with an isolated common. For example, inputs X0-X2 are in a group with their common terminal.

### BX-RTB10 Screw Terminal Block Kit

This terminal block kit includes 2 10-pin 3.8 mm terminal blocks (**BX-RTB10**). These are 90-degree screw terminal blocks. Wire is 180-degree pass through.



**BX-RTB10**

### BX-RTB10-2 Screw Terminal Block Kit

This terminal block kit includes (2) 10-pin 3.8 mm terminal blocks (**BX-RTB10-2**). These are 180-degree screw terminal blocks. Wire is 180-degree pass through.



**BX-RTB10-2**

### BX-RTB10-1 Screw Terminal Block Kit

This terminal block kit includes 2 10-pin 3.8 mm terminal blocks (**BX-RTB10-1**). These are 90-degree screw terminal blocks. Wire is 180-degree pass through.

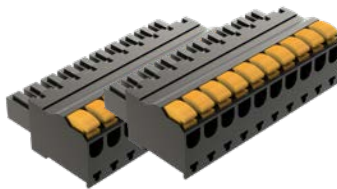

**BX-RTB10-1**

## Removable Terminal Block Specifications

Part Number	<b>BX-RTB10</b>	<b>BX-RTB10-1</b>	<b>BX-RTB10-2</b>
Price (pkg)	\$18.50	\$21.00	\$19.00
Connector Type	Screw Type-90-degree	Spring Clamp Type-180-degree	Screw Type-180-degree
Wire Exit	180-degree	180-degree	180-degree
Pitch	3.81 mm	3.81 mm	3.81 mm
Screw Size	M2	N/A	M2
Recommended Screw Torque	<1.77 lb-in (0.2 N-m)	N/A	<1.77 lb-in (0.2 N-m)
Screwdriver Blade Width	2.5 mm	2.5 mm	2.5 mm
Wire Gauge (Single Wire)	28-16 AWG	28-18 AWG	30-16 AWG
Wire Gauge (Dual Wire)	28-16 AWG	30-20 AWG (Dual Wire Ferrule Required)	30-18 AWG
Wire Strip Length	0.24 in (6mm)	0.35 in (9mm)	0.26 in (6.5 mm)
Equiv. Dinkle part #	EC381V-10P-BK	ESC381V-10-BK	EC381F-10P-BK



# Wiring Solutions

## ZIPLink Pre-Wired Cable Solutions

ZIPLinks eliminate the normally tedious process of wiring between devices by utilizing prewired cables and DIN-rail mount connector modules. It's as simple as plugging in a cable connector at either end or terminating wires at only one end. Prewired cables keep installation clean and efficient, using less space at a fraction of the cost of standard terminal blocks. ZIPLink prewired cables can connect

directly to a ZIPLink remote terminal block module, or with the pigtail option they can allow for a convenient solution to wire the BRX platform to third-party devices. For the BX 10/10E MPUs, one cable and one feedthrough module is needed to connect to all the onboard wiring termination points.

Two feedthrough module options are available, the [ZL-RTB20](#) and the [ZL-RTB20-1](#). The [ZL-RTB20](#) is a standard feedthrough terminal module and the [ZL-RTB20-1](#) is a compact feedthrough terminal block module having a compact footprint taking up less space in the control cabinet.

BX 10/10E ZIPLink Selector				
MPU Part Number	Component Type	Module Part Number	Cable Part Number*	Max Quantity Needed
<a href="#">BX-DM1-10ED1-D</a>	Feedthrough	<a href="#">ZL-RTB20</a> (Standard) OR <a href="#">ZL-RTB20-1</a> (Compact)	<a href="#">ZL-BX-CBL20</a> <a href="#">ZL-BX-CBL20-1</a> <a href="#">ZL-BX-CBL20-2</a>	1
<a href="#">BX-DM1-10ED2-D</a>				
<a href="#">BX-DM1-10ER-D**</a>				
<a href="#">BX-DM1-10AR-D**</a>				
<a href="#">BX-DM1E-10ED13-D</a>				
<a href="#">BX-DM1E-10ED23-D</a>				
<a href="#">BX-DM1E-10ER3-D**</a>				
<a href="#">BX-DM1E-10AR3-D**</a>				

\* Select the cable length: Blank = 0.5 m, -1 = 1.0 m, -2 = 2.0 m.

Available pigtail cables: [ZL-BX-CBL20-1P](#) = 1.0 m, [ZL-BX-CBL20-2P](#) = 2.0 m.

\*\* The relay outputs are derated not to exceed 2A per common when used with the ZIPLink wiring system.





# Wiring Solutions

## ZIPLink Pre-wired Cables

Custom molded ZIPLink prewired cables allow for fast and easy connection of field wiring to the BRX platform. The prewired

cable is 0.5 meter in length. Pigtail cables are used to connect the BRX platform directly to third-party devices, reducing

your wiring time and cost. The pigtail cable is 1 meter in length.



Pre-wired ZIPLink Cable



ZIPLink Pigtail Cable

## ZIPLink Remote Feedthrough Modules

Remote feedthrough modules provide low-cost and compact field wiring screw termination solutions for quickly connecting with the BRX platform. Two

(2) modules are available for use with the BRX platform, the ZL-RTB20 and the ZL-RTB20-1. The ZL-RTB20 is a standard 2-row, 20-pin, DIN-rail mountable

feedthrough module. The ZL-RTB20-1 is a compact 3-row, 24-pin, DIN-rail mountable feedthrough module with a smaller footprint design.

ZIPLink Module Specifications		
Part Number	ZL-RTB20 (Maximum of 4 needed)	ZL-RTB20-1 (Maximum of 4 needed)
Number of positions	20 screw terminals, 2 rows	24 screw terminals, 3 rows
Screwdriver Width	1/8 in (3.8 mm) maximum	
Screw Torque	4.4 lb-in (0.5 N-m)	4.4 lb-in (0.5 N-m)



ZL-RTB20



ZL-RTB20-1

# BRX Pluggable Option Modules (POM)

## Overview

All BRX Do-more! MPUs have an available slot to receive one BRX Pluggable Option Module (POM). Available POM configurations are:

- RS-232 3-pin serial port
- RS-232 5-pin serial port
- RS-232 RJ12 port
- RS-422 5-pin serial port
- RS-485 serial port
- Ethernet port (RJ45)
- USB Type B Port

POM modules are hot swappable giving you the ability to utilize different communication options while the system is running. For example, you can configure the system using a POM RJ45 Ethernet port to talk with a C-more panel. Then hot swap to the USB POM for programming. When programming is complete hot swap back to the RJ45 Ethernet POM without needing to power cycle or reconfigure the system.



**NOTE:** Pluggable Option Modules cannot be installed in BRX Remote I/O modules (e.g., BX-DMIO, BX-MBIO, BX-EBC100).



**BX-P-SER2-TERM**  
RS-232 Port



**BX-P-SER2-TERMFC**  
RS-232 Port  
w/ Flow Control



**BX-P-SER4-TERM**  
RS-485 Port



**BX-P-SER422-TERM**  
RS-422 Port



**BX-P-SER2-RJ12**  
RS-232 Port (RJ12)



**BX-P-ECOMLT**  
Ethernet Port (RJ45)



**BX-P-ECOMEX**  
Ethernet Port



**BX-P-USB-B**  
USB Type B Port

BRX Programmable Option Modules		
Expansion Module Part No.	Price	Description
<b><u>BX-P-SER2-TERM</u></b>	\$68.00	Non-isolated Serial port for communication via RS-232. Includes ESD protection and built-in surge protection.
<b><u>BX-P-SER2-TERMFC</u></b>	\$71.00	Non-isolated Serial port for communication via RS-232, with flow control. Includes ESD protection and built-in surge protection.
<b><u>BX-P-SER4-TERM</u></b>	\$69.00	Non-isolated Serial port for communication via RS-485. Includes ESD protection and built-in surge protection.
<b><u>BX-P-SER422-TERM</u></b>	\$67.00	Non-isolated Serial port that can communicate via RS-422. Includes ESD protection and built-in surge protection.
<b><u>BX-P-SER2-RJ12</u></b>	\$68.00	Non-isolated Serial port for communication via RS-232. Includes ESD protection and built-in surge protection.
<b><u>BX-P-ECOMLT</u></b>	\$95.00	Standard transformer isolated Ethernet port (1 Mbps throughput max) with built-in surge protection.
<b><u>BX-P-ECOMEX</u></b>	\$106.00	General-purpose standard transformer isolated Ethernet port (10/100 Mbps) with built-in surge protection.
<b><u>BX-P-USB-B</u></b>	\$43.50	USB Type B Port for programming.

## General Specifications

General specifications common to all the POM modules are listed in the table below.

General Specifications	
<b>Operating Temperature</b>	0° to 60°C (32° to 140°F)
<b>Storage Temperature</b>	-20° to 85°C (-4° to 185°F)
<b>Humidity</b>	5% to 95% (non-condensing)
<b>Environmental Air</b>	No corrosive gases permitted
<b>Vibration</b>	IEC60068-2-6 (Test Fc)
<b>Shock</b>	IEC60068-2-27 (Test Ea)
<b>Enclosure Type</b>	Open equipment
<b>Agency Approvals</b>	UL 61010-2 - UL File # E185989 Canada and USA CE Compliant E185989*
<b>Noise Immunity</b>	NEMA ICS3-304
<b>EU Directive</b>	See the "EU Directive" in Appendix B of the User Manual or topic DMD0331 in the Help File.
<b>Weight</b>	7g (0.25 oz)

\*Meets EMC and Safety requirements. See the D.O.C. for details.

## BRX POM Capabilities

	<b>BX-P-SER2-TERM</b>	<b>BX-P-SER2-TERMFC</b>	<b>BX-P-SER4-TERM</b>	<b>BX-P-SER422-TERM</b>	<b>BX-P-SER2-RJ12</b>	<b>BX-P-ECOMLT*</b>	<b>BX-P-ECOMEX</b>	<b>BX-P-USB-B</b>
<b>Monitoring &amp; Programming</b>	X	X	X	X	X	X	X	X
<b>Do-more! Protocol</b>	X	X	X	X	X	X	X	
<b>Modbus RTU Master</b>	X	X	X	X	X		X	
<b>Modbus RTU Slave</b>	X	X	X	X	X		X	
<b>Modbus TCP (Server)</b>						X	X	
<b>HTTP</b>							X	
<b>MQTT Client</b>							X	
<b>FTP</b>							X	
<b>EtherNet/IP</b>							X	
<b>K-Sequence (Slave)</b>	X	X	X	X	X	X	X	
<b>ASCII (In &amp; Out)</b>	X	X	X	X	X		X	
<b>Custom Protocols</b>	X	X	X	X			X	

\* Limited to 1 Mbps throughput max

# BRX Programming Software & Cable Assembly

## Do-more! Designer Programming Software

Free [Download](#)  
Part No. [DM-PGMSW](#)  
Part No. [DM-PGMSW-USB](#)

Do-more! Designer Programming software is a full-featured programming software for all BRX Series PLCs, Do-more! H2 Series PLCs and Do-more! T1H Series PLCs. Do-more! Designer Software is free. It can be downloaded from [Automationdirect.com](http://Automationdirect.com), or can be purchased on CD-ROM or USB.

FREE  
Retired  
\$13.00



## [BX-PGM-CBL](#) \$35.50

The programming cable assembly connects your PC to any BRX MPU and enables you to program and configure the BRX MPU using the free Do-more! Designer software. BX-PGM-CBL includes (1) BX-P-USB-B USB POM module and (1) [USB-CBL-AB6](#) standard USB Type A to USB Type B connector cable.



# BRX Accessories

## Replacement Battery

### D0-MC-BAT \$3.00

A battery is included with all BRX MPUs and is used to retain the time and data along with any tagname values that are set up as retentive. It is recommended that the battery be replaced once every five years or when one year of cumulative OFF time has been exceeded.



Battery	
<u>D0-MC-BAT</u>	Coin type, 3.0V Lithium battery, number CR2032

## BRX Blank Custom Slot Labels

### BX-LBL-1 \$36.50

BRX Blank custom slot labels, package of 10. For use with 18-point and 36-point BRX PLCs. (10) labels and (1) custom label slot cover included.



## BRX Access Cover Kit

### BX-ACC-1 \$9.75

BRX Access cover kit, replacement. For use with all BRX PLCs. Includes (1) battery cover, (1) expansion slot cover, (1) blank POM slot insert and (1) custom label slot.

