

BX-xxTD1 Sinking 12-24 VDC Output Modules

Please note: \$US prices shown
For current \$AUD visit www.directautomation.com.au

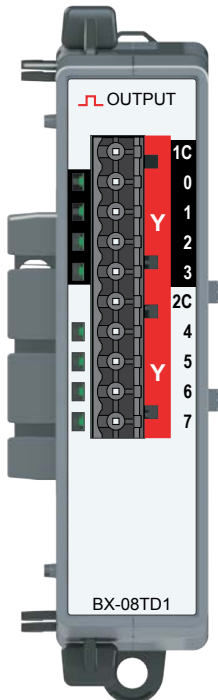

BX-08TD1 \$63.00

Output Module 8-pt,
12-24 VDC, Sinking

Terminal Blocks or
ZIPLink Cable
Sold Separately

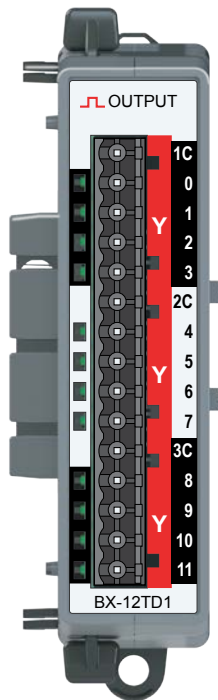

BX-12TD1 \$93.00

Output Module 12-pt,
12-24 VDC, Sinking

Terminal Blocks or
ZIPLink Cable
Sold Separately

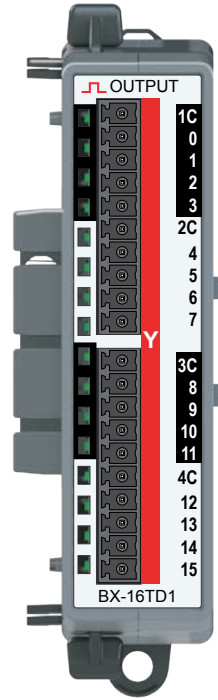

BX-16TD1 \$99.00

Output Module 16-pt,
12-24 VDC, Sinking

Terminal Blocks or
ZIPLink Cable
Sold Separately

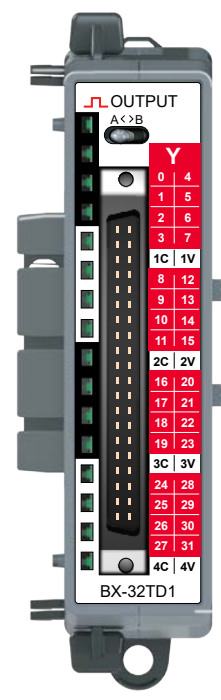

BX-32TD1 \$141.00

Output Module 32-pt,
12-24 VDC, Sinking

ZIPLink Cable
Sold Separately

Discrete Output Specifications

	BX-08TD1	BX-12TD1	BX-16TD1	BX-32TD1
Output Type	Sinking			
Outputs per Module	8	12	16	32
Commons (Isolated)	2	3	4	4
Points per Common	4	4	4	8
Maximum Current per Common	2A			
Nominal Voltage Range*	12-24 VDC			
Operating Voltage Range*	5-36 VDC			
Maximum Voltage	36VDC			
Minimum Output Current	0.1 mA @ 24VDC			
Maximum Output (Load) Current	0.5 A per output, no derating over temperature range			
Maximum Inrush Current	5A for 50ms			
Maximum Leakage Current	10µA			
ON Voltage Drop	0.05 VDC			
OFF-ON Response	< 5ms			
ON-OFF Response	< 2ms			
Overcurrent Protection	N/A			
Fuse Type	User-supplied external fuse			
Status Indicators	Logic Side, Green (32-point module has 16 LEDs for half of inputs, switchable via A/B switch)			
* Class 2 or LPS Power Supply required.				

IMPORTANT!



Hot-Swapping Information

Note: This device cannot be Hot Swapped.

BX-xxTD1 Sinking 12–24 VDC Output Modules, continued

Discrete Output Wiring

BX-08TD1 / BX-12TD1 / BX-16TD1

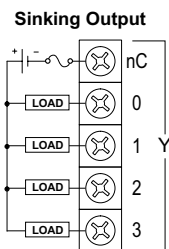

We recommend using prewired ZIPLink cables and connection modules. If you wish to hand-wire your module, a removable terminal block is available. See *Wiring Termination Selection* for all options.

BX-32TD1

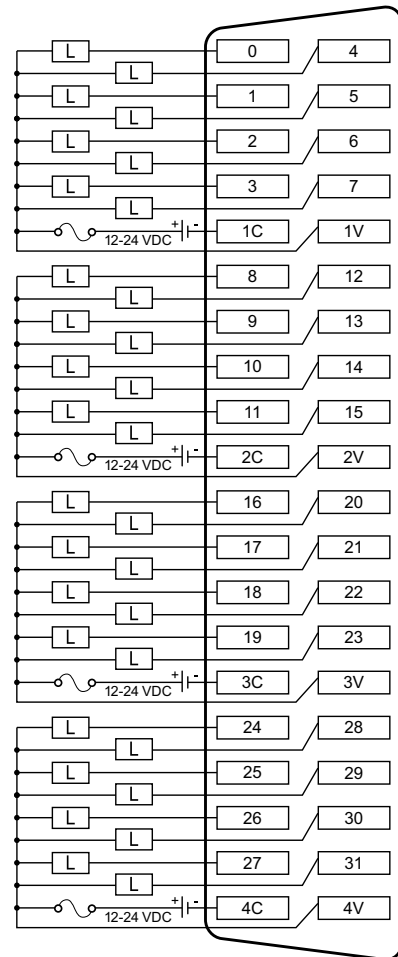

NOTE: 32-point modules are not compatible with terminal block connectors and require ZIPLink cables.

BRX Discrete Expansion Modules

Overview

One of the unique features of the BRX platform is its ability to expand its capability to fit your application solution. One of the ways the BRX platform can do this is by using expansion modules that conveniently “snap-on” to the side of any BRX MPU. Once the expansion module has been snapped in place and is added to the project, it instantly adds I/O to the MPU with little to no additional setup required.

The expansion modules give you the ability to add discrete I/O as needed and are identified as an input module, output module or combination input/output module. On the front panel of the discrete I/O

expansion modules, a color scheme and a symbol are used to denote the module type.

Most modules are available in 5, 8, 12 or 16 point variations consisting of sink/source DC inputs/outputs, AC inputs/outputs, relay outputs and combination modules. Some are available with 32 points.

The modules ship without wiring terminals. This allows you to select the termination style that best fits your application. Several wiring options are available, including screw terminal connectors, spring clamp terminal connectors and pre-wired ZIPLink cable solutions.

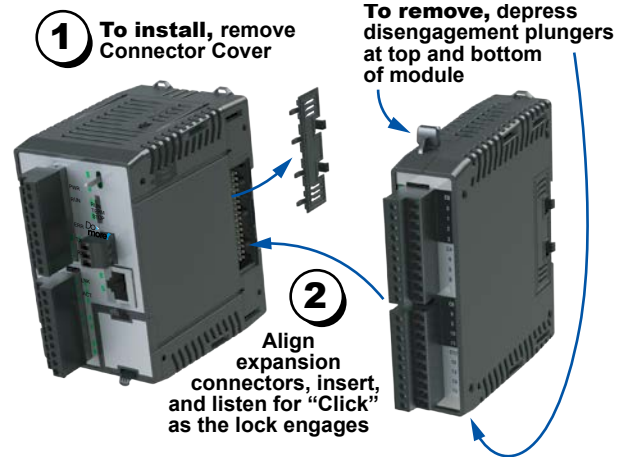

Hot-Swapping Information
 Note: This device cannot be Hot Swapped.

General Specifications

All BRX discrete expansion modules have the same general specifications listed in the table below.

General Specifications	
Operating Temperature	0° to 60°C (32° to 140°F)
Storage Temperature	-20° to 85°C (-4° to 185°F)
Humidity	5 to 95% (non-condensing)
Environmental Air	No corrosive gases permitted
Vibration	IEC60068-2-6 (Test Fc)
Shock	IEC60068-2-27 (Test Ea)
Enclosure Type	Open Equipment
Noise Immunity	NEMA ICS3-304
EU Directive	See the "EU Directive" topic in the Help File
Agency Approvals	UL 61010-2 - UL File # E185989 Canada and USA CE Compliant EN61131-2

Dimensions, inches[mm]

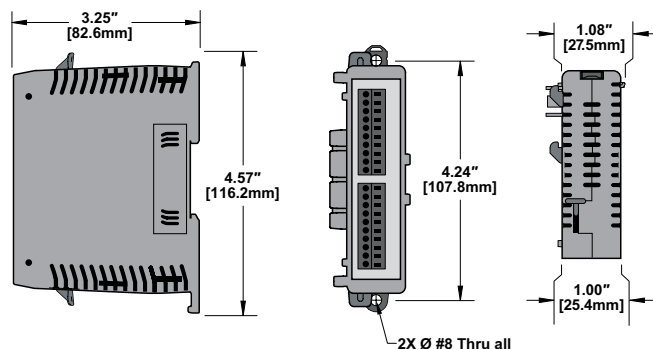

NOTE: When removing an expansion module make sure there is room for the module to slide away from the system. Failure to do so will result in difficulty in removing the module.

BRX Discrete Expansion Modules

Discrete Input Modules

Thirteen (13) discrete input modules are available in various DC and AC voltage ranges. Input module faceplates have a blue terminal bar and symbol  for easy distinction from other module types.

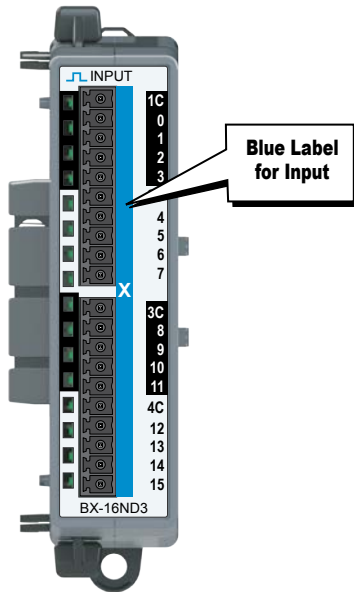

Discrete Input Modules			
Part Number	Points	Input Type	Price
BX-08NF3	8	3 – 5 VDC Sink / Source	\$55.00
BX-08ND3		12 – 24 VDC Sink / Source	\$54.00
BX-08NB		24VAC	\$49.00
BX-08NA		120VAC	\$53.00
BX-08SIM		Simulator	\$64.00
BX-12ND3	12	12 – 24 VDC Sink / Source	\$65.00
BX-12NB		24VAC	\$51.00
BX-12NA		120VAC	\$69.00
BX-16NF3	16	3–5 VDC Sink/Source	\$79.00
BX-16ND3		12 – 24 VDC Sink / Source	\$71.00
BX-16NB		24VAC	\$61.00
BX-16NA		120VAC	\$77.00
BX-32ND3	32	12 – 24 VDC Sink / Source	\$139.00

Discrete Output Modules

Eighteen (18) discrete output modules are available in DC sinking, DC sourcing, AC voltage and Relay type outputs. Output module faceplates have a red terminal bar and symbol  for easy distinction from other module types.

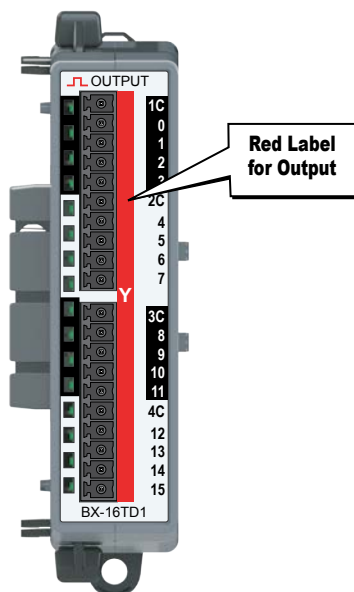

Discrete Output Modules			
Part Number	Points	Output Type	Price
BX-05TRS	5	Relay Form C (SPDT)	\$69.00
BX-05TRS-1		Relay Form C (SPDT)	\$85.00
BX-08TD1	8	12 – 24 VDC Sinking	\$63.00
BX-08TD2		12 – 24 VDC Sourcing	\$63.00
BX-08TR		Relay Form A (SPST)	\$69.00
BX-08TA		120 – 240 VAC Triac	\$111.00
BX-08TRZ		Relay Form A (SPST), no surge suppression	\$78.00
BX-12TD1	12	12 – 24 VDC Sinking	\$93.00
BX-12TD2		12 – 24 VDC Sourcing	\$85.00
BX-12TR		Relay Form A (SPST)	\$93.00
BX-12TA	16	120 – 240 VAC Triac	\$129.00
BX-16TD1		12 – 24 VDC Sinking	\$99.00
BX-16TD2		12 – 24 VDC Sourcing	\$99.00
BX-16TF2		3–5 VDC Sourcing	\$93.00
BX-16TR	16	Relay Form A (SPST)	\$105.00
BX-16TRZ		Relay Form A (SPST), no surge suppression	\$112.00
BX-32TD1	32	12 – 24 VDC Sinking	\$141.00
BX-32TD2		12 – 24 VDC Sourcing	\$140.00

BRX Discrete Expansion Modules

Discrete Combo Input / Output Modules

Six discrete input/output combo modules are available with DC sink/source inputs and sink/source/relay outputs. The Input/Output faceplate terminal bar is in blue and red, making it easy to distinguish between inputs and outputs and from other module types.

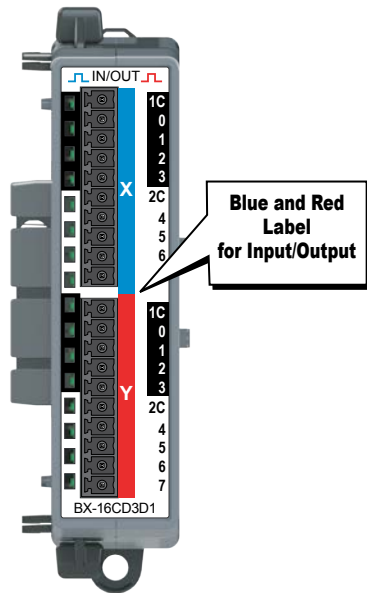

Discrete Combo Input / Output Modules					
Part Number	Points		Input Type	Output Type	Price
	Input	Output			
<u>BX-08CD3R</u>	4	4	12-24 VDC Sink / Source	Relay Form A (SPST)	\$69.00
<u>BX-12CD3D1</u>	8	4		12-24 VDC Sinking	\$69.00
<u>BX-12CD3D2</u>				12-24 VDC Sourcing	\$69.00
<u>BX-16CD3D1</u>	8	8		12-24 VDC Sinking	\$85.00
<u>BX-16CD3D2</u>				12-24 VDC Sourcing	\$92.00
<u>BX-16CF3F2</u>				3-5 VDC Sink/Source	3-5 VDC Sourcing

Expansion Module Support by Controller	
Controller Type	# Expansion Modules
<u>BX-DM1E-M</u>	8
<u>BX-DM1-10</u>	2
<u>BX-DM1E-10</u>	2
<u>BX-DM1-18</u>	4
<u>BX-DM1E-18</u>	8
<u>BX-DM1-36</u>	4
<u>BX-DM1E-36</u>	8
<u>BX-DMIO*</u>	8
<u>BX-EBC100*</u>	8
<u>BX-MBIO*</u>	8

* Remote I/O controllers do not support Motion Control and Communications Modules.

BRX Wiring Termination Options

Terminal Block Connectors

The terminal block connectors are provided in kits of multiple connectors that are ordered as a single part number. There are 2 different types of kits to choose from; one kit for the five (5), eight (8) and 12-point discrete, and one

kit for the analog modules and 16-point discrete modules. The five (5), eight (8) and 12-point discrete module kits each have (3) 5-pin 5mm connectors. The 8-point modules will use only 2 of the 5-pin connectors.

The five (5) and 12-point modules will use all three connectors. The analog and 16-point digital module kits include (2) 10-pin 3.81 mm connectors.

Terminal Block Connectors, 5, 8 and 12-Point Discrete Modules

Terminal Block Kits for 5-point, 8-point and 12-point Expansion Modules



BX-RTB08 (Kit - 3 pieces)



BX-RTB08-1 (Kit - 3 pieces)



BX-RTB08-2 (Kit - 3 pieces)

Terminal Block Specifications 5-, 8- & 12-Point Type

Part Number Single Block Set of 3 Blocks	<i>BX-RTB05</i> <i>BX-RTB08</i>	<i>BX-RTB05-1</i> <i>BX-RTB08-1</i>	<i>BX-RTB05-2</i> <i>BX-RTB08-2</i>
Price (Single Block)	\$8.50	\$7.00	\$8.00
Price (Kit)	\$15.00	\$14.50	\$15.00
Connector Type	Screw Type - 90-degree	Spring Clamp Type - 180-degree	Screw Type - 180-degree
Wire Exit	180-degree	180-degree	180-degree
Pitch	5.0 mm	5.0 mm	5.0 mm
Screw Size	M2.5	N/A	M2.5
Screw Torque Recommended	< 3.98 lb-in (0.45 N·m)	N/A	< 3.98 lb-in (0.45 N·m)
Screwdriver Blade Width	3.5 mm	3.5 mm	3.5 mm
Wire Gauge (Single Wire)	28-12 AWG	28-14 AWG	28-12 AWG
Wire Gauge (Dual Wire)	28-16 AWG	28-16 AWG (Dual Wire Ferrule Required)	28-16 AWG
Wire Strip Length	0.3 in (7.5 mm)	0.37 in (9.5 mm)	0.3 in (7.5 mm)
Equiv. Dinkle P/N	5ESDV-05P-BK	5ESDSR-05P-BK	5ESDF-05P-BK

Terminal Block Connectors, Analog Modules and 16-Point Discrete Modules

Terminal Block Kits for Analog and 16-point Discrete Expansion Modules



BX-RTB10 (Kit - 2 pieces)

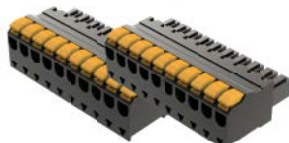

BX-RTB10-1 (Kit - 2 pieces)



BX-RTB10-2 (Kit - 2 pieces)

Terminal Block Specifications 16-Point Type

Part Number	<i>BX-RTB10</i>	<i>BX-RTB10-1</i>	<i>BX-RTB10-2</i>
Price (Kit)	\$21.50	\$24.00	\$22.50
Connector Type	Screw Type 90-degree	Spring Clamp Type 180-degree	Screw Type 180-degree
Wire Exit	180-degree	180-degree	180-degree
Pitch	3.81 mm	3.81 mm	3.81 mm
Screw Size	M2	N/A	M2
Screw Torque Recommended	<1.77 lb-in (0.2 N·m)	N/A	<1.77 lb-in (0.2 N·m)
Screwdriver Blade Width	2.5 mm	2.5 mm	2.5 mm
Wire Gauge (Single Wire)	28-16 AWG	26-18 AWG	30-16 AWG
Wire Gauge (Dual Wire)	28-18 AWG	30-20 AWG (Dual Wire Ferrule Required)	30-18 AWG
Wire Strip Length	0.24 in (6mm)	0.35 in (9mm)	0.26 in (6.5 mm)
Equiv. Dinkle P/N	EC381V-10P-BK	ESC381V-10-BK	EC381F-10P-BK



NOTE: BX-RTB10 terminal blocks are included with Temperature Input modules.

BRX Wiring Termination Options

ZIPLink Wiring System

BRX expansion modules can be quickly connected to convenient **ZIPLink** remote terminal blocks for ease of wiring I/O devices. Your **ZIPLink** selection is dependent on the number of expansion module terminal points. The following tables list the connector options.



8-Point BRX Discrete Expansion Module ZIPLink Selector

Expansion Module Part No.	ZIPLink Module	ZIPLink Module Part No.	Qty Needed	ZIPLink Cable Part No.*	Qty Needed
BX-08ND3	Feedthrough	ZL-RTB20 (Standard) OR ZL-RTB20-1 (Compact)	1	ZL-BXEM-CBL10 ZL-BXEM-CBL10-1 ZL-BXEM-CBL10-2	1
BX-08NF3					
BX-08NA					
BX-08NB					
BX-08TD1					
BX-08TD2					
BX-08TR**					
BX-08TRZ**					
BX-08TA					
BX-08CD3R**					

* Select cable length: Blank = 0.5 m, -1 = 1.0m, -2 = 2.0m.

Available pigtail cables: [ZL-BXEM-CBL10-1P](#) = 1.0 m, [ZL-BXEM-CBL10-2P](#) = 2.0 m.

** The relay outputs are derated not to exceed 2A per common when used with the **ZIPLink** wiring system.

12 & 5-Point BRX Discrete Expansion Module ZIPLink Selector

Expansion Module Part No.	ZIPLink Module	ZIPLink Module Part No.	Qty Needed	ZIPLink Cable Part No.*	Qty Needed
BX-12ND3	Feedthrough	ZL-RTB20 (Standard) OR ZL-RTB20-1 (Compact)	1	ZL-BXEM-CBL15 ZL-BXEM-CBL15-1 ZL-BXEM-CBL15-2	1
BX-12NA					
BX-12NB					
BX-12TD1					
BX-12TD2					
BX-12TR**					
BX-05TRS					
BX-12TA					
BX-12CD3D1					
BX-12CD3D2					

* Select cable length: Blank = 0.5 m, -1 = 1.0m, -2 = 2.0m.

Available pigtail cables: [ZL-BXEM-CBL15-1P](#) = 1.0 m, [ZL-BXEM-CBL15-2P](#) = 2.0 m.

** The relay outputs are derated not to exceed 2A per common when used with the **ZIPLink** wiring system.

BRX Wiring Termination Options

16-Point BRX Discrete Expansion Module ZIPLink Selector							
Expansion Module Part No.	ZIPLink Module	ZIPLink Module Part No.	Qty Needed	ZIPLink Cable Part No. *	Qty Needed		
<u>BX-16ND3</u>	Sensor	<u>ZL-LTB16-24-1</u>	1	<u>ZL-BXEM-CBL20</u> <u>ZL-BXEM-CBL20-1</u> <u>ZL-BXEM-CBL20-2</u>	1		
	Feedthrough	<u>ZL-RTB20</u> (Standard) OR <u>ZL-RTB20-1</u> (Compact)	1				
<u>BX-16NF3</u>	Feedthrough						
<u>BX-16NA</u>							
<u>BX-16NB</u>	Feedthrough						
<u>BX-16TD1</u>							
<u>BX-16TD2</u>	Relay (Sourcing)					<u>ZL-RRL16-24-1</u> , <u>ZL-RRL16W-24-1</u> , <u>ZL-RRL16F-24-1</u> , <u>ZL-RRL16HDF-24-1</u>	1
	Relay (Sinking)					<u>ZL-RRL16-24-2</u> , <u>ZL-RRL16W-24-2</u> , <u>ZL-RRL16F-24-2</u> , <u>ZL-RRL16HDF-24-2</u>	1
<u>BX-16TF2</u>	Feedthrough					<u>ZL-RTB20</u> (Standard) OR <u>ZL-RTB20-1</u> (Compact)	1
<u>BX-16TR**</u>							
<u>BX-16TRZ**</u>							
<u>BX-16CD3D1</u>							
<u>BX-16CD3D2</u>							
<u>BX-16CF3F2</u>							

* Select cable length: Blank = 0.5 m, -1 = 1.0m, -2 = 2.0m.

Available pigtail cables: ZL-BXEM-CBL20-1P = 1.0 m, ZL-BXEM-CBL20-2P = 2.0 m.

** The relay outputs are derated not to exceed 2A per common when used with the ZIPLink wiring system.

32-Point BRX Discrete Expansion Module ZIPLink Selector					
Expansion Module Part No.	ZIPLink Module	ZIPLink Module Part No.	Qty Needed	ZIPLink Cable Part No. *	Qty Needed
<u>BX-32ND3</u>	Sensor	<u>ZL-LTB32-24-1</u>	1	<u>ZL-D24-CBL40</u> <u>ZL-D24-CBL40-1</u> <u>ZL-D24-CBL40-2</u>	1
	Feedthrough	<u>ZL-RTB40</u> (Standard) OR <u>ZL-RTB40-1</u> (Compact)	1		
<u>BX-32TD1</u>					
<u>BX-32TD2</u>					

* Select cable length: Blank = 0.5 m, -1 = 1.0m, -2 = 2.0m.

Available pigtail cables: ZL-D24-CBL40-1P = 1.0 m, ZL-D24-CBL40-2P = 2.0 m.

Suffix -X indicates 45° cable connector angle. Non -X indicates 180° cable connector angle.

16-Point BRX High Speed Expansion Module ZIPLink Selector					
Expansion Module Part No.	ZIPLink Module	ZIPLink Module Part No.	Qty Needed	ZIPLink Cable Part No. *	Qty Needed
<u>BX-HSIO4</u>	Feedthrough	<u>ZL-RTB40</u> (Standard) OR <u>ZL-RTB40-1</u> (Compact)	1	<u>ZL-BX-CBL40-S</u> <u>ZL-BX-CBL40-1S</u>	1

BRX Wiring Termination Options

BRX Analog and Temperature Expansion Module <i>ZIPLink</i> Selector						
Expansion Module Part No.	<i>ZIPLink</i> Module	<i>ZIPLink</i> Module Part No.	Qty Needed	<i>ZIPLink</i> Cable Part No. ¹	Qty Needed	
BX-04ADM-1	Feedthrough	ZL-RTB20 (Standard) OR ZL-RTB20-1 (Compact)	1	ZL-BXEM-CBL20 ZL-BXEM-CBL20-1 ZL-BXEM-CBL20-2	1	
BX-04AD-1						
BX-08AD-1						
BX-16AD-1						
BX-04AD-2B						
BX-08AD-2B						
BX-16AD-2B						
BX-04DA-1						
BX-08DA-1						
BX-04DA-2B						
BX-08DA-2B						
BX-2AD2DA-1						
BX-4AD2DA-1						
BX-2AD2DA-2B						
BX-4AD2DA-2B						
BX-08AD-3				ZL-BXEM-CBL10 ZL-BXEM-CBL10-1 ZL-BXEM-CBL10-2	1	
BX-08DA-3				Temperature Input modules are not supported by the <i>ZIPLink</i> wiring system.		
BX-2AD2DA-3						
BX-4AD4DA-3						
BX-04THM						
BX-08THM						
BX-06RTD						
BX-08NTC						
BX-04UT						
BX-08UT						
BX-4THM4DA-1						
BX-4RTD4DA-1						
BX-4UT4DA-3						
BX-4UT4TD1						
BX-4UT4TD2						
BX-4UT4TR						

1. Select cable length: Blank = 0.5 m, -1 = 1.0m, -2 = 2.0m.

Available pigtail cables: [ZL-BXEM-CBL20-1P](#) = 1.0 m, [ZL-BXEM-CBL20-2P](#) = 2.0 m.