

P2-SCM Serial Communication Module

P2-SCM **\$234.00**

Please note: \$US prices shown
For current \$AUD visit www.directautomation.com.au

Serial Communications Module

Productivity® 2000 serial communications module provides three RS-232 ports and one RS-485 port. This configuration allows Modbus master/slave networking or connection to serial devices using ASCII or custom communication protocols.

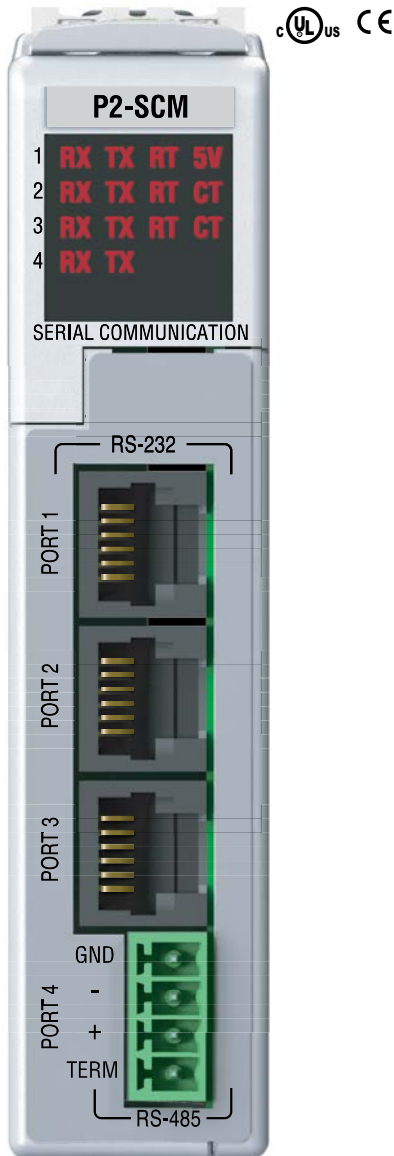

General Specifications	
Module Type	Intelligent
Modules per Base	15 maximum (See Note)
I/O Points Used	None, mapped directly to tags in CPU
Field Wiring Connector	3 - RJ12, 1 - 4 Position Terminal Block
Operating Temperature	0° to 60°C (32° to 140°F)
Storage Temperature	-20° to 70°C (-4° to 158°F)
Humidity	5 to 95% (non-condensing)
Environmental Air	No corrosive gases permitted
Vibration	IEC 60068-2-6 (Test Fc)
Shock	IEC 60068-2-27 (Test Ea)
Field to Logic Side Isolation	None
Insulation Resistance	No isolation
Module Location	Any slot in any base in a Productivity2000 system
Weight	90g (3.2 oz)
Agency Approvals**	UL508 File E139594, Canada & USA CE (EN61131-2007)*

*Meets EMC and Safety requirements. See the Declaration of Conformity for details.
 **To obtain the most current agency approval information, see the Agency Approval Checklist section on the specific component part number web page.

Removable Terminal Block Specifications	
Number of Positions	4 Screw Terminals, 3.5mm pitch
Wire Range	16-28 AWG Solid/Stranded Conductor "Use copper conductors, 75°C or equivalent"
Screwdriver Size	TW-SD-VSL-1 (recommended)
Screw Torque	0.4 N·m

Removable Terminal Connector included. Spare connectors available (part no. [P3-RS485CON-1](#)).

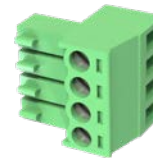

RS-485 Cable Options	
Recommended	Q8302-1 (cut to length) or Belden #9841 equivalent.

P2-SCM Serial Communication Module

Diagnostic LEDs				
LED	Port 1	Port 2	Port 3	Port 4
RXD	X	X	X	X
TXD	X	X	X	X
RTS	X	X	X	
CTS		X	X	
5V	X			

- All RS232 & RS485 LED's reflect the actual electrical level of the signal; there is no direct firmware control of LED's.
- RS232 LED's RXD, TXD, RTS & CTS are turned ON when the voltage on the RS232 wire is positive:
 - This occurs when the UART I/O signal is low (GND).
 - They are turned OFF when the voltage on the RS232 wire is negative.
- RS485 LED's RXD & TXD are turned ON when the UART I/O signal is low (GND).
- 5V LED is ON when 5V power is good, 5V LED is OFF when 5V is shorted to ground.

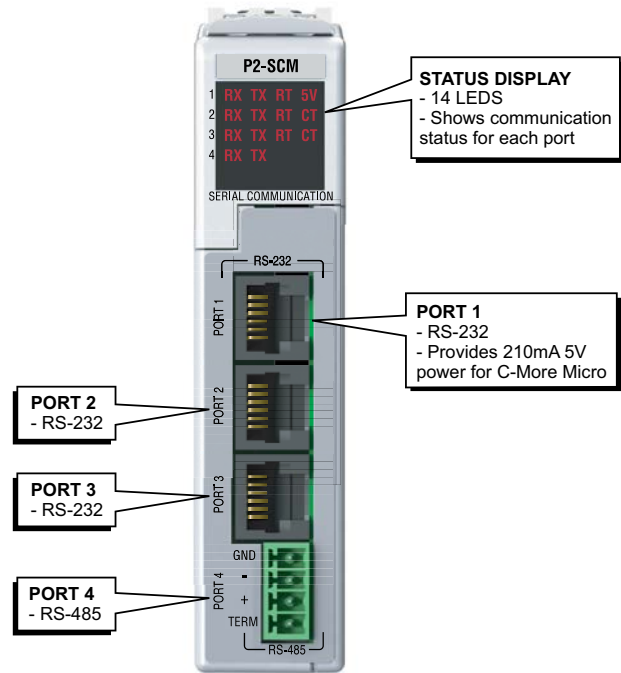

P2-SCM Configuration Options			
Configuration Item	Port 1 (RS-232)	Ports 2 & 3 (RS-232)	Port 4 (RS-485)
Protocol Selections	Disabled, Modbus RTU, ASCII/Custom	Disabled, Modbus RTU, ASCII/Custom	Disabled, Modbus RTU, ASCII/Custom
Data Rate	1200, 2400, 4800, 9600, 19200, 33600, 38400 baud	1200, 2400, 4800, 9600, 19200, 33600, 38400 baud	1200, 2400, 4800, 9600, 19200, 33600, 38400 baud
Parity	None, Odd or Even	None, Odd or Even	None, Odd or Even
Data Bits ⁴	7 or 8 bits	7 or 8 bits	7 or 8 bits
RTS Off Delay Time ¹	None, or 0–5000 ms	None, or 0–5000 ms	N/A
RTS On Delay Time ¹	None, or 0–5000 ms	None, or 0–5000 ms	N/A
Modbus Character Timeout ²	None, or 0–10000 ms	None, or 0–10000 ms	None, or 0–10000 ms
Communication Timeout (Timeout between query and response)	500–10500 ms	500–10500 ms	500–10500 ms
Response/Request Delay Time	N/A	N/A	None, or 1–5000 ms
Comm Heartbeat Value ²	2–1000 sec	2–1000 sec	2–1000 sec
Node Address (Station)	1 to 247	1 to 247	1 to 247
CTS	N/A	Ignore, Wait, System Input ³	N/A
Enable/Disable CTS Wait Timeout	1–9999 tenths of seconds	1–9999 tenths of seconds	N/A
RTS	On, Off, Assert During Transmit, System Output	On, Off, Assert During Transmit, System Output	N/A
RS-485 2-Wire Mode	N/A	N/A	Disable, Enable
Modbus Port Security	Read/Write, Read Only	Read/Write, Read Only	Read/Write, Read Only

1. For "None" selection with Modbus RTU protocol, www.modbus.org minimums are used. This minimum is 3.5 character times up to 19,200 baud rate and 1.75 ms over 19200 baud rate.
 2. Only applies to Modbus messages.
 3. CTS signal is only provided on Ports 2 & 3.
 4. 7-bit data are only supported with Odd or Even parity.

P2-SCM Serial Communication Module

Serial Port 1	
Port Type	RS-232
Description	Non-isolated RS-232 DTE port connects the CPU as a Modbus/ASCII master or slave to a peripheral device. Includes ESD and built-in surge protection.
Data Rates	Selectable, 1200, 2400, 4800, 9600, 19200, 33600, and 38400
+5V Cable Power Source	210mA maximum at 5V, ±5%. Reverse polarity and overload protected
TXD	RS-232 Transmit output
RX	RS-232 Receive input
RTS	Handshaking output for modem control
GND	Logic ground
Maximum Output Load (TXD/RTS)	3kΩ, 1000pF
Minimum Output Voltage Swing	±5V
Output Short Circuit Protection	±15mA
Port Status LED	Red LED is illuminated when active for TXD, RXD and RTS
Cable Options	EA-MG-PGM-CBL D2-DSCBL USB-RS232 with D2-DSCBL FA-CABKIT FA-ISOCAN for converting RS-232 to isolated RS-485

Port 1

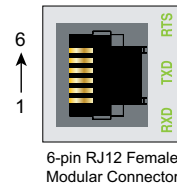

Pin #	Signal	
6	GND	Logic Ground
5	RTS	RS-232 Output
4	TXD	RS-232 Output
3	RXD	RS-232 Input
2	+5V	210mA Maximum
1	GND	Logic Ground

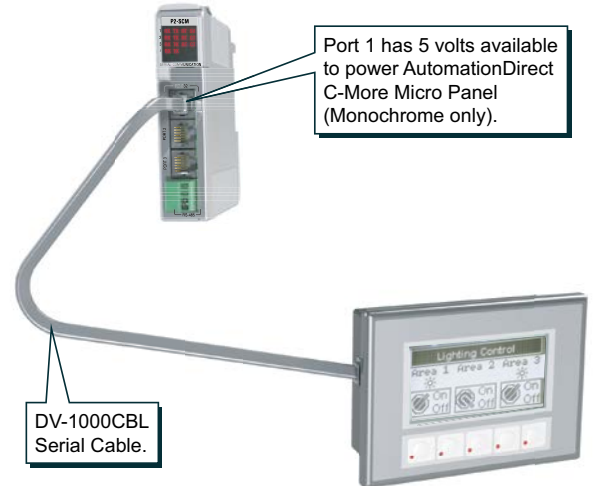

Ports 2, and 3

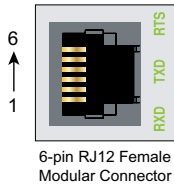

Pin #	Signal	
6	GND	Logic Ground
5	RTS	RS-232 Output
4	TXD	RS-232 Output
3	RXD	RS-232 Input
2	CTS	RS-232 Input
1	GND	Logic Ground

Serial Port 2 and 3	
Port Type	RS-232
Description	Non-isolated RS-232 DTE port connects the CPU as a Modbus/ASCII master or slave to a peripheral device. Includes ESD and built-in surge protection.
Data Rates	Selectable, 1200, 2400, 4800, 9600, 19200, 33600, and 38400
TXD	RS-232 Transmit output
RX	RS-232 Receive input
RTS	Handshaking output for modem control
GND	Logic ground
Maximum Output Load (TXD/RTS)	3kΩ, 1,000pF
Minimum Output Voltage Swing	±5V
Output Short Circuit Protection	±15mA
Port Status LED	Red LED is illuminated when active for TXD, RXD and RTS
Cable Options	D2-DSCBL USB-RS232 with D2-DSCBL FA-CABKIT FA-ISOCAN for converting RS-232 to isolated RS-485

RS-232 Ports 1, 2 & 3				
Electrical Specifications	Min	Typ	Max	Units
Output ON, Space Condition (3kΩ, 1000pF Load)	5.0	5.2	N/A	Volts
Output OFF, Mark Condition (3kΩ, 1000pF Load)	N/A	-5.2	-5.0	Volts
Output Short-Circuit Current	N/A	15	N/A	mA
Short-Circuit Duration	N/A	N/A	No Limit	Seconds
Output Resistance	300	N/A	N/A	Ohm
Input ON Threshold	N/A	1.6	2.4	Volt
Input OFF Threshold	0.6	1.2	N/A	Volt
Input Resistance	3k	5k	7k	Ohm

Line Specifications for RS-232 Ports		
RS-232 Line Specifications	Options	Units
Data Rate Setting	1200, 2400, 4800, 9600, 19200, 33600, 38400	Baud
Data Rate Error	±2	%
Data Bits Setting1	7 or 8	Bits
Stop Bits Setting	1	Bits
Parity Setting	None1, Odd or Even	Parity
Data Transmission	Half duplex or full duplex	N/A
Network	Point-to-Point	

1. 7-bit data are only supported with odd or even parity.

P2-SCM Serial Communication Module

Port 4	
Port Type	RS-485
Description	Non-isolated RS-485 port connects the CPU as a Modbus/ASCII master or slave to a peripheral device. Includes ESD/EFT protection and automatic echo cancellation when transmitter is active.
Data Rates	Selectable, 1200, 2400, 4800, 9600, 19200, 33600, 38400 baud
TXD+/RXD	RS-485 transceiver high
TXD-/RXD-	RS-485 transceiver low
GND	Logic Ground
Input Impedance	19kΩ
Maximum Load	50 transceivers, 19kΩ each, 60Ω termination
Output Short Circuit Protection	±250mA, thermal shut-down protection
Electrostatic Discharge Protection	±8kV per IEC1000-4-2
Electrical Fast Transient Protection	±2kV per IEC1000-4-4
Minimum Differential Output Voltage	1.5 V with 60Ω load
Fail Safe Inputs	Logic high input state if inputs are unconnected
Maximum Common Mode Voltage	-7.5 V to 12.5 V
Port Status LED	RED LED illuminated when active for TXD and RXD
Cable Options	Recommend ADC #Q8302-1 (cut to length)

Port 4

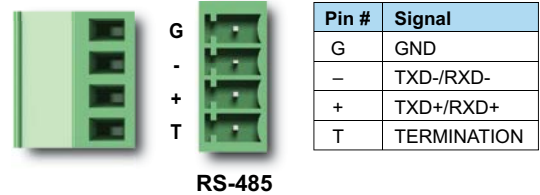

Line Specifications for RS-485 Port		
RS-485 Line Specifications	Options	Units
Data Rate Setting	1200, 2400, 4800, 9600, 19200, 33600, 38400	Baud
Data Bits Setting¹	7 or 8	Bits
Stop Bits Setting	1	Bits
Parity Setting	None ¹ , Odd or Even	Parity
Data Transmission	Half duplex	N/A

1. 7-bit data is only supported with odd or even parity.

Port 4				
Electrical Specifications	Min	Typ	Max	Units
Driver Differential Output (54Ω Load)	1.5	N/A	N/A	Volts
Driver Common-Mode Output			3	Volts
Driver Short-Circuit Output Current	N/A		250	mA
Short-Circuit Duration (Thermal Shutdown)			No Limit	Seconds
Receiver Differential Input Threshold	200		N/A	mV
Receiver Common-Mode Input	-7		12	Volt
Input Resistance	12k			Ohm
Termination Resistance (TB Jumper wire 'T' to '+')	N/A	120	N/A	Ohm
Data Rate	1200	N/A	38400	Baud
Data Rate Error			±2	%
Cable Length (38400 baud maximum)	N/A		1200	Meter

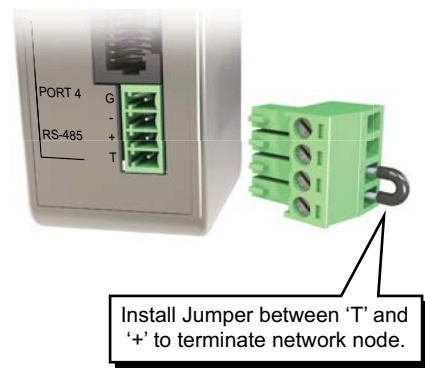

* Jumper not included