

P2-550 CPU Module

Please Note: \$US prices shown
For current \$AUD visit www.directautomation.com.au

P2-550 \$361.00

The P2-550 is a high-performance CPU which has communications ports that support Ethernet and serial devices. The P2-550 also includes a 4-line x 10-character OLED local display and a USB programming port.

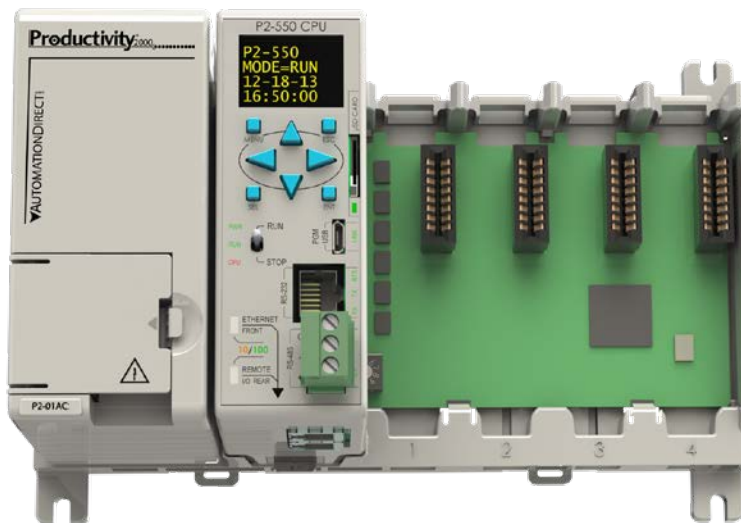
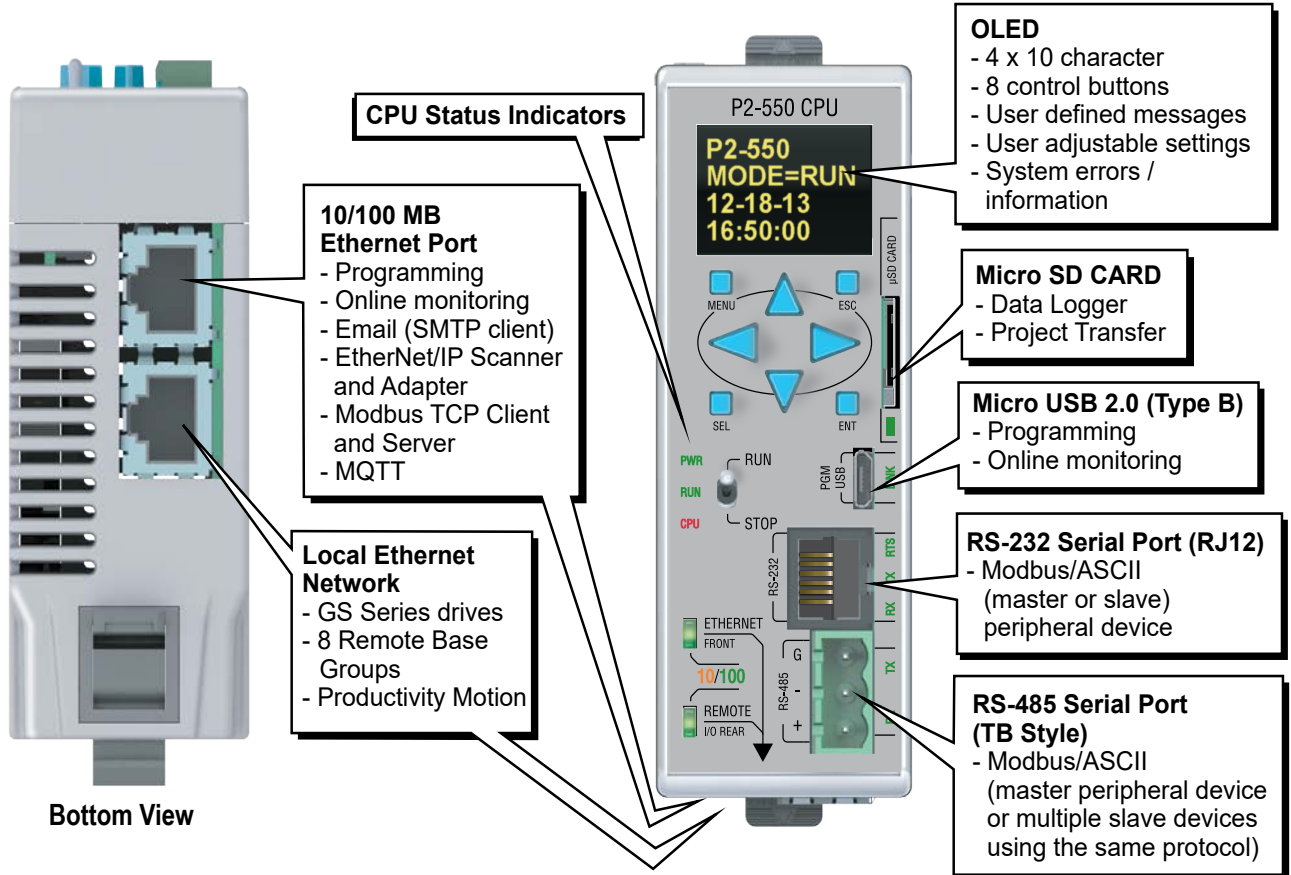

Each Productivity2000 system base requires a CPU module be mounted in the controller slot of the unit. The CPU stores and executes the user's program.

P2-550 CPU Module

CPU Run/Stop Switch	
RUN position	Executes user program, run-time edits possible
STOP position	Does not execute user program, normal program load position

CPU Status Indicators	
PWR	Green LED is illuminated when power is ON
RUN	Green LED is illuminated when CPU is in RUN mode
CPU	Red LED is illuminated during power ON reset or power down.



CPU Specifications															
User Memory	50MB (Includes program, data and documentation)														
Memory Type	Flash and Battery Backed RAM														
Retentive Memory	500kB														
Scan Time	500µs (3K Boolean, 240 I/O)														
Display	OLED, 4x10 characters, 8 control buttons														
Communications; 5 Integrated Ports	<p>USB: Programming, Monitoring, Debug, Firmware</p> <p>ETHERNET: (10/100 Mbps Ethernet) Programming, Monitoring, Debug, Firmware, Email SMTP Client, MQTT, Modbus TCP Client (32 Servers) and Server (16 Clients), EtherNet/IP Scanner (32 Adapters) and Adapter (4 scanners) with 8 connections per device.</p> <p>REMOTE I/O: 16 GS series drives, 8 Remote Base Groups, 4 ProtosX TCP couplers, 4 PS-AMC modules</p> <p>RS-232: (RJ12, 1200–115.2k baud) ASCII, Modbus</p> <p>RS-485: Removable Terminal Included, (1200–115.2k baud) ASCII, Modbus RTU</p>														
Data Logging/ Project Transfer	Micro SD card slot														
Hardware Limits of System	9 Base Groups: 1 Local (P2-550) + 8 Remote (P2-RS and/ or P1-RX) + 4 ProtosX TCP couplers + 4 PS-AMC 4,320 Hardware I/O points (All 32-point modules)														
Instruction Types	<table border="0"> <tr> <td>Application Functions</td> <td>PID</td> </tr> <tr> <td>Array Functions</td> <td>Program Control</td> </tr> <tr> <td>Counters/Timers</td> <td>String Functions</td> </tr> <tr> <td>Communications</td> <td>System Functions</td> </tr> <tr> <td>Data Handling</td> <td>Contacts</td> </tr> <tr> <td>Drum Sequencers</td> <td>Coils</td> </tr> <tr> <td>Math Functions</td> <td>Motion Control</td> </tr> </table>	Application Functions	PID	Array Functions	Program Control	Counters/Timers	String Functions	Communications	System Functions	Data Handling	Contacts	Drum Sequencers	Coils	Math Functions	Motion Control
Application Functions	PID														
Array Functions	Program Control														
Counters/Timers	String Functions														
Communications	System Functions														
Data Handling	Contacts														
Drum Sequencers	Coils														
Math Functions	Motion Control														
Real Time Clock Accuracy	±5s per day typical at 25°C -15s per day maximum at 60°C														

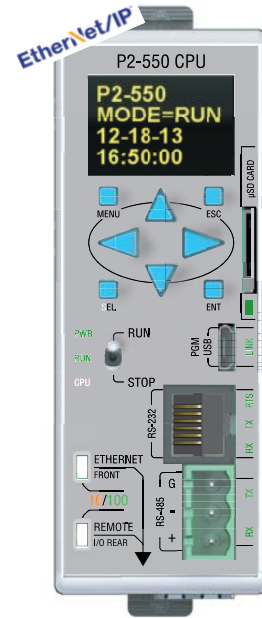

IMPORTANT!



Hot-Swapping Information
NOTE: This device cannot be Hot Swapped.

P2-550 CPU Module

Specifications

General Specifications	
Operating Temperature	0° to 60°C (32° to 140°F)
Storage Temperature	-20° to 70°C (-4° to 158°F)
Humidity	5 to 95% (non-condensing)
Altitude	2,000 meters, max.
Pollution Degree	2
Environmental Air	No corrosive gases permitted
Vibration	IEC60068-2-6 (Test Fc)
Shock	IEC60068-2-27 (Test Ea)
Heat Dissipation	3.81 W
Overtoltage Category	II
Enclosure Type	Open equipment
Module Location	Controller slot in the local base in a Productivity@2000 system.
Weight	158g (5.6 oz)
Agency Approvals**	UL 61010-1 and UL 61010-2-201 File E139594, Canada and USA CE (EN 61131-2 EMC, EN 61010-1 and EN 61010-2-201 Safety)*

*Meets EMC and Safety requirements. See the Declaration of Conformity for details.
**To obtain the most current agency approval information, see the Agency Approval Checklist section on the specific component part number web page.

CPU Installation

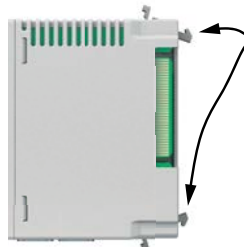

Step One:

Unlock both locking tabs

WARNING: DO NOT APPLY FIELD POWER UNTIL THE FOLLOWING STEPS ARE COMPLETED.

Step Two:

Seat CPU on support platform and push towards base until circuit board is fully engaged into connector

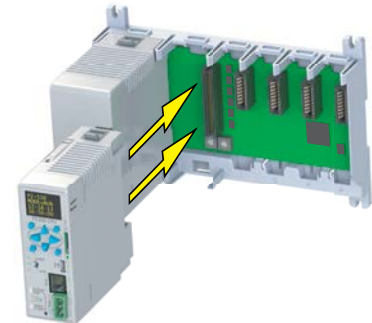

Step Three:

Snap retaining tab into the locked position.

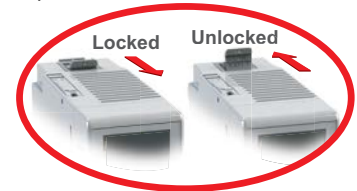

WARNING: EXPLOSION HAZARD - DO NOT CONNECT OR DISCONNECT OR OPERATE SWITCHES WHILE CIRCUIT IS LIVE UNLESS THE AREA IS KNOWN TO BE NON-HAZARDOUS. DO NOT HOT-SWAP MODULES UNLESS THE AREA IS KNOWN TO BE NON-HAZARDOUS.

OLED Message Display

The P2-550 CPU incorporates a 4-line by 10-character OLED (Organic Light-Emitting Diode) display for system alarms, information and for displaying user-defined messages.

Control buttons located beneath the OLED display allow the user to navigate through menu items. These buttons also permit local configuration of time and date settings.

User defined display messages may be configured using the Productivity Suite Programming Software. A "Display Page" dialog box allows the user to program text into user-defined tags that will be displayed based on the programmed ladder execution.

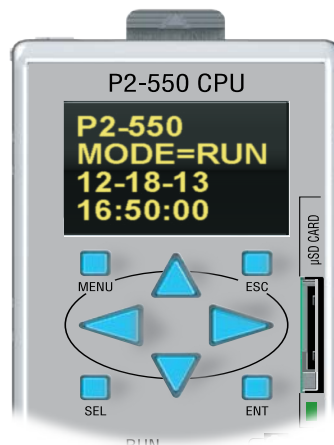

OLED Control Buttons

Menu Button	Access the OLED menu
ESC Button	Returns to the previous screen
SEL Button	Selects the desired menu option
ENT Button	Starts the selected process
Directional Arrows	Moves the cursor around the 4 Row x 10 Column OLED

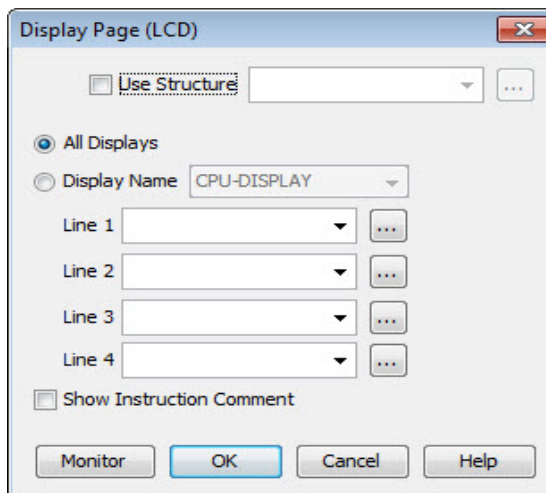

P2-550 CPU Module

Port Specifications

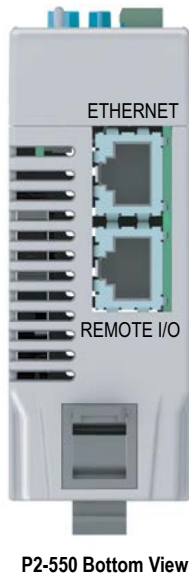
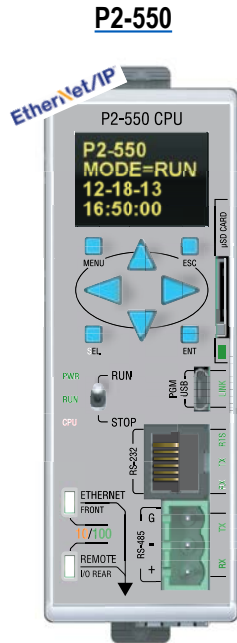

P2-550 Bottom View

Ethernet Port (On bottom of CPU)

RJ-45 style connector used for:

- Connection to a PC running the ProductivitySuite programming software
- Modbus TCP Client connections (Modbus requests sent from the CPU)
- Modbus TCP Server connections (Modbus requests received by the CPU)
- EtherNet/IP Scanner (32 Adaptors)
- EtherNet/IP Adapter (4 scanners) with 8 connections per device.
- Outgoing E-mail

Remote I/O Port (On bottom of CPU)

RJ-45 style connector used for connecting to a Remote I/O network consisting of GS-EDRV100 units connected to GS drives.

Ethernet Specifications		
Port Name	ETHERNET	REMOTE I/O
Description	Standard transformer isolated Ethernet port with built-in surge protection for programming, online monitoring, Email (SMTP client), Modbus/TCP client/server connections (fixed IP or DHCP) and EtherNet/IP Scanner/Adapter connections.	Standard transformer isolated Ethernet port with built-in surge protection for connection to 16 GS series drives, 8 remote base groups, and 4 PS-AMC modules.
Transfer Rate	10 Mbps (Orange LED) and 100 Mbps (Green LED) (auto-crossover).	
Port Status LED	LED is solid when network LINK is established. LED flashes when port is active (ACT).	

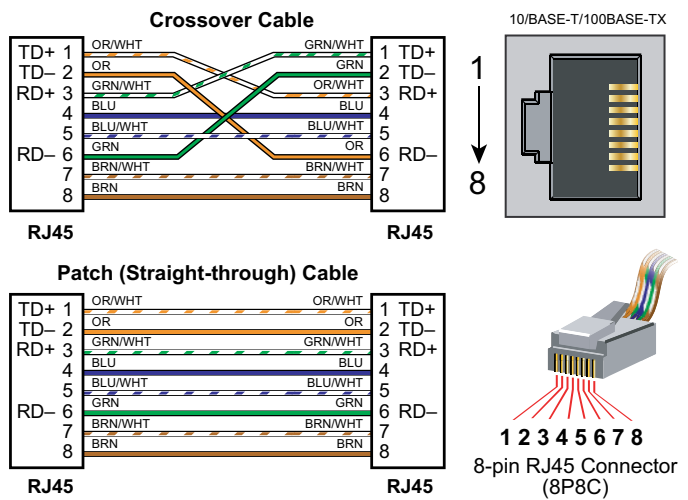

P2-550 CPU Module

Port Specifications

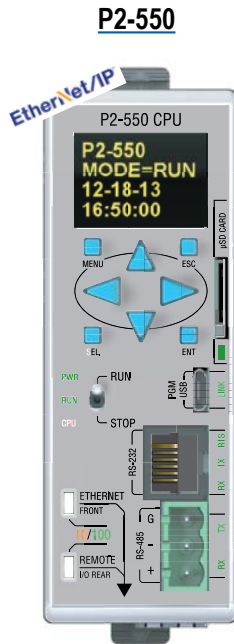

MICRO USB Programming Port

Used exclusively for connecting to a PC running the Productivity Suite programming software.

Micro USB Input Specifications	
Port Name	MICRO USB
Description	Standard Micro USB Slave input for programming and on-line monitoring, with built-in surge protection. Not compatible with older full speed USB devices.
Transfer Rate	480 Mbps
Port Status LED	Green LED is illuminated when LINK is established to programming software.
Cables	USB Type A to Micro USB Type B: 6ft cable part # USB-CBL-AMICB6 15ft cable part # USB-CBL-AMICB15

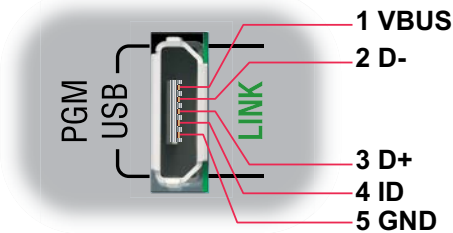

P2-550 CPU Module

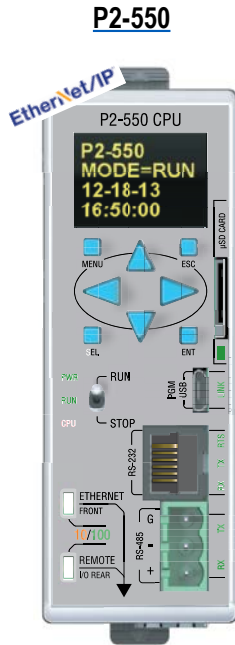

RS-232 Port

RJ-12 style connector used for:

- Modbus RTU Master connections
- Modbus RTU Slave connections
- ASCII full or half duplex communications
- Custom Protocol Incoming and Outgoing communications

RS-232 Specifications	
Port Name	RS-232
Description	Non-isolated RS-232 DTE port connects the CPU as a Modbus/ASCII master or slave to a peripheral device. Includes ESD and built-in surge protection
Data Rates	Selectable, 1200, 2400, 4800, 9600, 19200, 33600, 38400, 57600, and 115200 baud
+5V Cable Power Source	210mA maximum at 5V, ±5%. Reverse polarity and overload protected
TXD	RS-232 Transmit output
RXD	RS-232 Receive input
RTS	Handshaking output for modem control
GND	Logic ground
Maximum Output Load (TXD/RTS)	3kΩ, 1000pf
Minimum Output Voltage Swing	±5V
Output Short Circuit Protection	±15mA
Port Status LED	Green LED is illuminated when active for TXD, RXD and RTS
Cable Options	EA-MG-PGM-CBL D2-DSCBL USB-RS232 with D2-DSCBL FA-CABKIT FA-ISOCOCON for converting RS-232 to isolated RS-485



6-pin RJ12 Female Modular Connector

Pin #	Signal
6	GND Logic Ground
5	RTS RS-232 Output
4	TXD RS-232 Output
3	RXD RS-232 Input
2	+5V 210mA Maximum
1	GND Logic Ground

P2-550 CPU Module

P2-550

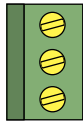
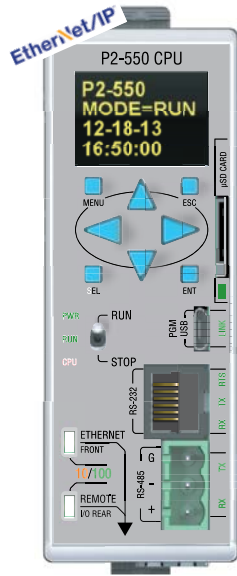

Removable connector included.
Spare connectors available (part no. [P3-RS485CON](#)).

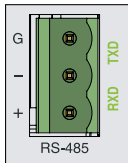

Pin #	Signal
G	GND
-	TXD-/RXD-
+	TXD+/RXD+

RS-485 Port

A 3-pin removable terminal block used for:

- Modbus RTU Master connections
- Modbus RTU Slave connections
- ASCII Incoming and Outgoing communications
- Custom Protocol Incoming and Outgoing communication

RS-485 Port Specifications

Port Name	RS-485
Description	Non-isolated RS-485 port connects the CPU as a Modbus/ASCII master or slave to a peripheral device. Includes ESD/EFT protection and automatic echo cancellation when transmitter is active
Data Rates	Selectable, 1200, 2400, 4800, 9600, 19200, 33600, 38400, 57600, and 115200
TXD+ /RXD+	RS-485 transceiver high
TXD- /RXD-	RS-485 transceiver low
GND	Logic ground
Input Impedance	19kΩ
Maximum Load	50 transceivers, 19kΩ each, 60Ω termination
Output Short Circuit Protection	±250mA, thermal shut-down protection
Electrostatic Discharge Protection	Contact ±4kV, Air 8kV per IEC1000-4-2 Cable is installed for testing.
Electrical Fast Transient Protection	±1kV per IEC1000-4-4
Minimum Differential Output Voltage	1.5 V with 60Ω load
Fail Safe Inputs	Logic high input state if inputs are unconnected
Maximum Common Mode Voltage	-7.5 V to 12.5 V
Port Status LED	Green LED illuminated when active for TXD and RXD
Cable Options	Go to www.AutomationDirect.com for RS-485 cables

Removable Terminal Block Specifications

Part Number	P3-RS485CON
Number of Positions	3 Screw Terminals
Pitch	5mm
Wire Range	28-12 AWG Solid Conductor 30-12 AWG Stranded Conductor
Screw Driver Width	1/8 inch (3.175 mm) maximum
Screw Size	M2.5
Screw Torque	4.5 lb·in (0.51 N·m)