

## P1-M401-12DRS

The P1-M401-12DRS is a P1000 CPU with 8 integrated sinking/sourcing inputs and 4 relay outputs. This PLC can be used as a stand-alone controller for small applications, or expanded with 2 additional P1000 I/O modules.

CPU Specifications . . . . .	2
CPU Status Indicators . . . . .	2
Input Specifications . . . . .	3
Output Specifications . . . . .	3
CPU Front Panel . . . . .	3
Module Installation Procedure . . . . .	4
Wiring Options . . . . .	4
Schematic and Wiring Diagrams . . . . .	5
RS-232 Specifications . . . . .	6
USB-C Specifications . . . . .	6
Removable Terminal Block Specifications . . . . .	7
General Specifications . . . . .	8
Warning . . . . .	8

Terminal Block sold separately, (see wiring options on page 4).

CPU Specifications															
<b>User Memory</b>	32MB (Includes program, data and documentation)														
<b>Memory Type</b>	Flash and RAM														
<b>Retentive Memory</b>	27KB														
<b>Scan Time</b>	1.7 ms (1K Boolean, Max I/O)														
<b>External Power Required</b>	24VDC $\pm 2\%$ @ 5W plus 1.25 W per additional I/O module.														
<b>Protection Circuit</b>	Not built into module – Install protection element such as Edison S5061-R, Time Delay, 1A Fuse														
<b>Communication; 2 Integrated Ports</b>	<b>USB IN:</b> Programming, Monitoring, Debug, Firmware <b>RS-232:</b> (RJ-12, 1200-115.2 k baud) ASCII, Modbus														
<b>Hardware Limits of System</b>	<b>Onboard I/O Points:</b> 8 sink/source inputs and 4 relay outputs <b>Expansion I/O Point Limit:</b> 32 (2 modules with up to 16 points each)														
<b>Instruction Types</b>	<table border="0"> <tr> <td>Application Functions</td> <td>PID</td> </tr> <tr> <td>Array Functions</td> <td>Program Control</td> </tr> <tr> <td>Counters/Timers</td> <td>String Functions</td> </tr> <tr> <td>Communications</td> <td>System Functions</td> </tr> <tr> <td>Data Handling</td> <td>Contacts</td> </tr> <tr> <td>Drum Sequencers</td> <td>Coils</td> </tr> <tr> <td>Math Functions</td> <td></td> </tr> </table>	Application Functions	PID	Array Functions	Program Control	Counters/Timers	String Functions	Communications	System Functions	Data Handling	Contacts	Drum Sequencers	Coils	Math Functions	
Application Functions	PID														
Array Functions	Program Control														
Counters/Timers	String Functions														
Communications	System Functions														
Data Handling	Contacts														
Drum Sequencers	Coils														
Math Functions															
<b>Real Time Clock</b>	None														

CPU Status Indicators	
<b>PWR</b>	Green LED is illuminated when power is ON
<b>RUN</b>	Green LED is illuminated when CPU is in RUN mode
<b>CPU</b>	Red LED is illuminated during power ON reset, power down, or watch-dog time-out

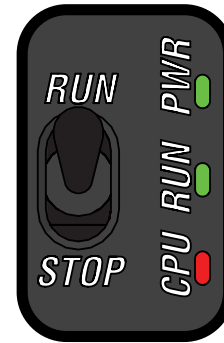

CPU Run/Stop Switch Specifications	
<b>RUN position</b>	Executes user program, run-time edits possible
<b>STOP position</b>	Does not execute user program, normal program load position

# CPU Front Panel

Input Specifications	
<b>Inputs per Module</b>	8 (sink/source)
<b>Rated Voltage</b>	24VAC/VDC
<b>Operating Voltage Range</b>	20.4–27.6 VAC/VDC
<b>Peak Voltage Range</b>	27.6 VAC/30VDC
<b>AC Frequency</b>	47–63 Hz
<b>Input Current</b>	8mA @ 24VAC/VDC <sup>1</sup>
<b>Maximum Input Current</b>	10mA @ 27.6 VAC, 30VDC
<b>Input Impedance</b>	3kΩ
<b>Minimum ON Current</b>	2.5 mA
<b>Maximum OFF Current</b>	0.5 mA
<b>ON Voltage Level</b>	>9.5 VDC, >8VAC
<b>OFF Voltage Level</b>	<4.5 VDC, <4VAC
<b>OFF to ON Response</b>	AC: 10ms DC: 6ms
<b>ON to OFF Response</b>	AC: 20ms DC: 10ms
<b>Status Indicators</b>	Logic Side (8 points)
<b>Commons</b>	2 (4 points/common)

Output Specifications	
<b>Outputs per Module</b>	4
<b>Rated Voltage</b>	6–30 VDC, 6–120 VAC
<b>Operating Voltage Range</b>	5–30 VDC, 5–144 VAC
<b>Output Type</b>	Relay, Form A (SPST)
<b>AC Frequency</b>	47–63 Hz
<b>Maximum Output Current</b>	5A / point <sup>1</sup> 2A / per point if used with ZIPLink Cable
<b>Minimum Load Current</b>	5mA @ 5VDC
<b>Maximum Inrush Current</b>	5A for 10ms
<b>OFF to ON, ON to OFF Response</b>	≤ 10 ms
<b>Status Indicators</b>	Logic Side (4 points)
<b>Commons</b>	4 (1 points/common)
<b>Protection Circuit</b>	Not built into module – Install protection elements such as an external fuse – 8A.

1. See temperature derating chart for inputs and outputs in P1000 User Manual.

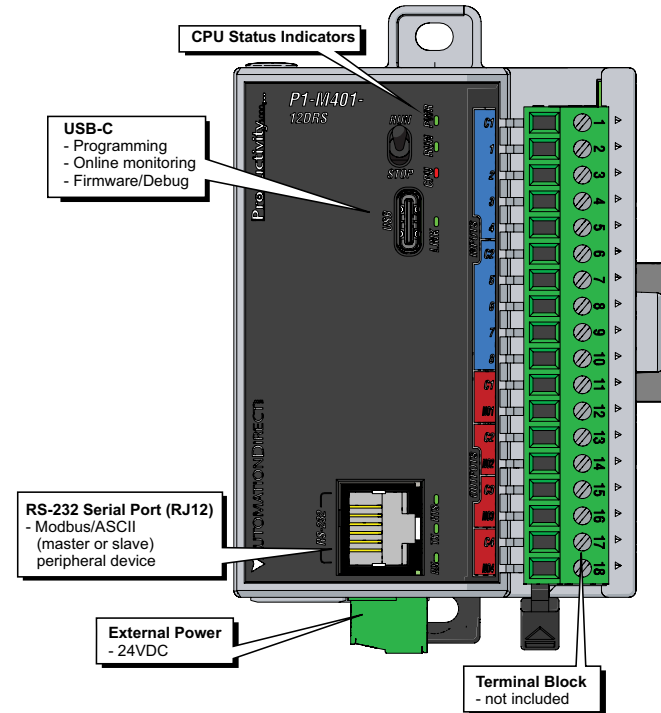

# Module Installation

**WARNING:** Do not add or remove modules with field power applied.

**Step One:** With latch in "locked" position, align connectors on the side of each module and stack by pressing together. Click indicates lock is engaged.

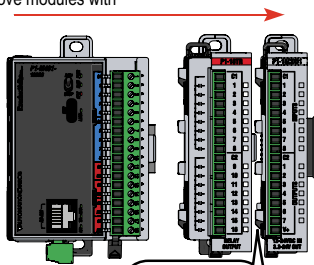

**Step Two:** Attach field wiring using the removable terminal block or ZIPlink wiring system.

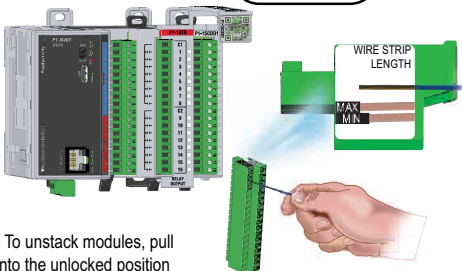

**Step Three:** To unstack modules, pull locking latch up into the unlocked position and then pull modules apart.

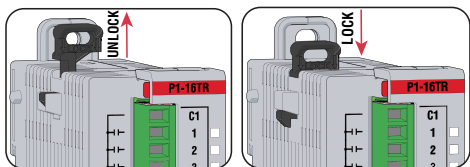

## Wiring Options

### 1 ZIPlink Feed Through Modules and Cables<sup>1</sup>

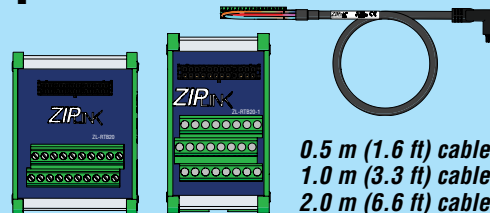

ZL-RTB20  
ZL-RTB20-1

ZL-P1-CBL18  
ZL-P1-CBL18-1  
ZL-P1-CBL18-2

### 2 Terminal Block with pigtail cable

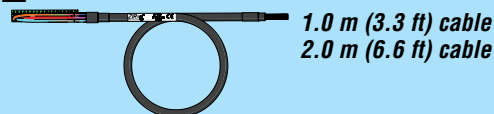

ZL-P1-CBL18-1P  
ZL-P1-CBL18-2P

### 3 Screw Terminal Block only

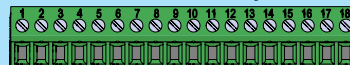

P2-RTB  
(Quantity 1)

### 4 Spring Clamp Terminal Block only

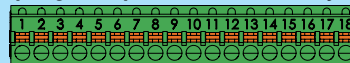

P2-RTB-1  
(Quantity 1)

### 5 Accessories<sup>2</sup>



ZL-RTB-COM

TW-SD-SL-1

TW-SD-MSL-1

1. Cable + ZIPlink Module = Complete System

2. ZL-RTB-COM provides a common connection point for power or ground in a small footprint.

# Schematic and Wiring Diagram

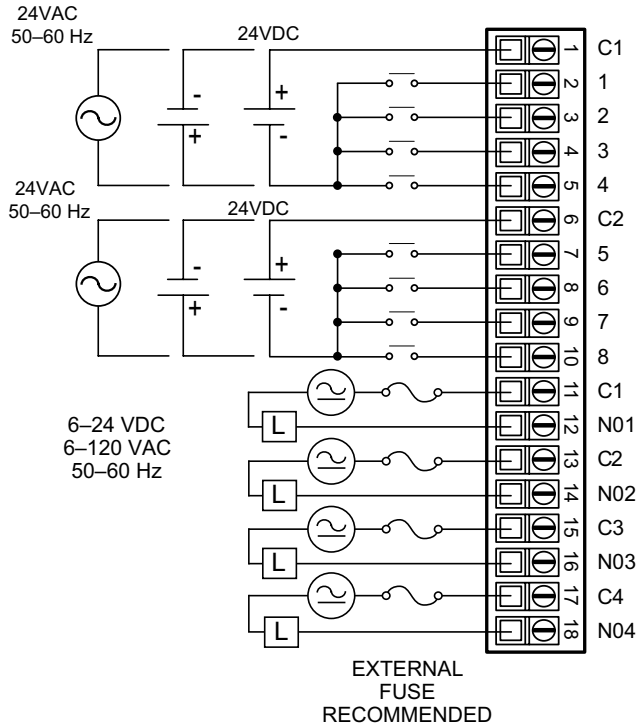

## Equivalent Input Circuit

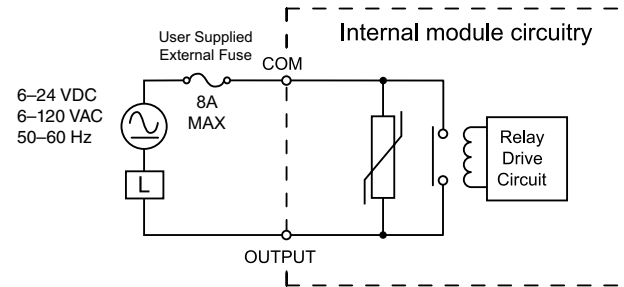
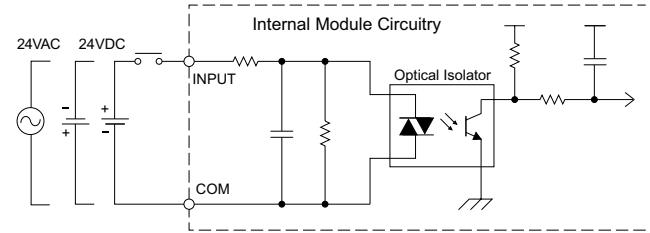

# Port Specifications

## RS-232 Specifications

<b>Port Name</b>	<b>RS-232</b>
<b>Description</b>	Non-isolated RS-232 DTE port connects the CPU as a Modbus/ASCII master or slave to a peripheral device. Includes ESD and built-in surge protection
<b>Data Rates</b>	Selectable, 1200, 2400, 4800, 9600, 19200, 33600, 38400, 57600, and 115200
<b>+5V Cable Power Source</b>	210mA maximum at 5V, ±5%. Reverse polarity and overload protected
<b>TXD</b>	RS-232 Transmit output
<b>RXD</b>	RS-232 Receive input
<b>RTS</b>	Handshaking output for modem control
<b>GND</b>	Logic ground
<b>Maximum Output Load (TXD/RTS)</b>	3kΩ, 1000 pf
<b>Minimum Output Voltage Swing</b>	±5 V
<b>Output Short Circuit Protection</b>	±15 mA
<b>Port Status LED</b>	Green LED is illuminated when active for TXD, RXD and RTS
<b>Cable Options</b>	EA-MG-PGM-CBL D2-DSCBL USB-RS232-1 with D2-DSCBL FA-CABKIT FA-ISOCON for converting RS-232 to isolated RS-485

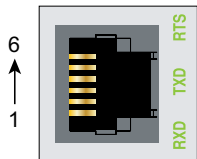

6-pin RJ12 Female Modular Connector

Pin #	Signal
6	GND Logic Ground
5	RTS RS-232 Output
4	TXD RS-232 Output
3	RXD RS-232 Input
2	+5V 210mA Maximum
1	GND Logic Ground

## USB-C Specifications

<b>Port Name</b>	<b>USB-C</b>
<b>Description</b>	Standard USB-C Slave input for programming and online monitoring and firmware update with built-in surge protection. Not compatible with older full speed USB devices.
<b>Transfer Rate</b>	480 Mbps
<b>Port Status LED</b>	Green LED is illuminated when LINK is established to programming software.
<b>Cables</b>	USB Type A to Micro USB Type C: 6ft cable part # USB-CBL-AC6

Power Removable Terminal Block Specifications	
<b>Part Number</b>	PCON-KIT
<b>Number of Positions</b>	3 Screw Terminals
<b>Pitch</b>	3.5 mm
<b>Wire Range</b>	28–16 AWG Solid Conductor 28–16 AWG Stranded Conductor
<b>Screw Driver Width</b>	1/8 in (3.175 mm) Maximum
<b>Screw Size</b>	M2
<b>Screw Torque</b>	1.7 lb-in (0.4 N-m)

Input/Output Removable Terminal Block Specifications		
<b>Part Number</b>	<b>P2-RTB</b>	<b>P2-RTB-1</b>
<b>Positions</b>	18 Screw Terminals	18 Spring Clamp Terminals
<b>Wire Range</b>	30–16 AWG (0.051–1.31 mm <sup>2</sup> ) Solid / Stranded Conductor 3/64 in (1.2 mm) Insulation Max. 1/4 in (6–7 mm) Strip Length	28–16 AWG (0.081–1.31 mm <sup>2</sup> ) Solid / Stranded Conductor 3/64 in (1.2 mm) Insulation Max. 19/64 in (7–8 mm) Strip Length
<b>Conductors</b>	*USE COPPER CONDUCTORS, 75°C* or equivalent.	
<b>Screw Driver</b>	0.1 in (2.5 mm) Maximum*	
<b>Screw Size</b>	M2	N/A
<b>Screw Torque</b>	2.5 lb-in (0.28 N-m)	N/A

\*Recommended Screw Driver TW-SD-MSL-1

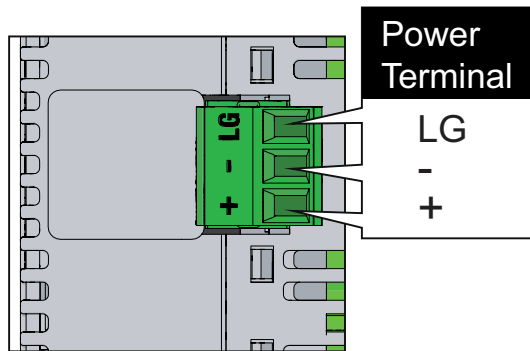

General Specifications	
<b>Operating Temperature</b>	0° to 60°C (32° to 140°F)
<b>Storage Temperature</b>	-20° to 70°C (-4° to 158°F)
<b>Humidity</b>	5 to 95% (non-condensing)
<b>Altitude</b>	2,000 meters max
<b>Pollution Degree</b>	2
<b>Environmental Air Vibration</b>	No corrosive gases permitted IEC60068-2-6 (Test Fc)
<b>Shock</b>	IEC60068-2-27 (Test Ea)
<b>Overvoltage Category</b>	II
<b>Field to Logic Side Isolation</b>	Relays to Backplane 2.7 kVAC for 5s or 800VAC for 1 Min. Discrete Input to Backplane 1.25 kVAC for 5s or 300VAC for 1 Min.
<b>Field to Field Isolation</b>	Discrete Input 8 to Relay C1 1.35 kVAC for 5s or 400VAC for 1 Min. Relay to Relay 1.35 kVAC for 5s or 400VAC for 1 Min.
<b>Insulation Resistance</b>	>10MΩ @ 500VDC
<b>Heat Dissipation</b>	3432mW
<b>Enclosure Type</b>	Open Equipment
<b>Module Location</b>	Controller in a Productivity1000 System.
<b>Field Wiring</b>	Use <b>ZIP</b> link Wiring System or removable terminal block (Sold Separately). See "Wiring Options" on page 4.
<b>Terminal Type (sold separately)</b>	18-Position Removable Terminal Block
<b>Weight</b>	128g (4.52 oz)
<b>Agency Approvals</b>	UL 61010-1 and UL 61010-2-201 File E139594, Canada & USA <sup>1</sup> CE (EN 61131-2 EMC, EN 61010-1 and EN 61010-2-201 Safety)*

\*See CE Declaration of Conformance for details.

1. See P1000 User Manual for Temperature Derating Chart and Insulation Requirements for IEC/UL 61010-1 and 61010-2-201 (section 6.5 and 6.7)

**WARNING:** To minimize the risk of potential safety problems, you should follow all applicable local and national codes that regulate the installation and operation of your equipment. These codes vary from area to area and it is your responsibility to determine which codes should be followed, and to verify that the equipment, installation, and operation are in compliance with the latest revision of these codes.

**Equipment damage or serious injury to personnel can result from the failure to follow all applicable codes and standards. We do not guarantee the products described in this publication are suitable for your particular application, nor do we assume any responsibility for your product design, installation, or operation.**

If you have any questions concerning the installation or operation of this equipment, or if you need additional information, please call Technical Support at 770-844-4200.

This publication is based on information that was available at the time it was printed. At AutomationDirect.com® we constantly strive to improve our products and services, so we reserve the right to make changes to the products and/or publications at any time without notice and without any obligation. This publication may also discuss features that may not be available in certain revisions of the product.

Document Name	Edition/Revision	Date
P1-M401-12DRS-DS	1st Edition, Rev A	7/9/2025

Copyright 2025, AutomationDirect.com Incorporated/All Rights Reserved Worldwide