

Input Specifications	
Input Channels	4
Module Signal Input Range	0–20 mA
Signal Resolution	13-bit
Resolution Value of LSB (least significant bit)	0–20 mA = 2.44 μ A per count (1LSB = 1 count)
Data Range	0–8191 counts
Input Type	Sinking, Single-ended (1 common)
Maximum Continuous Overload	\pm 31mA
Input Impedance	247 Ω , \pm 0.5%, 1/4W Current Input
Filter Characteristics	Low Pass, -3dB @ 120Hz
Sample Duration Time	2.5 ms per channel (does not include ladder scan time)
All Channel Update Rate	10ms
Open Circuit Detection Time	Zero reading within 100ms
Conversion Method	Successive approximation
Accuracy vs. Temperature	\pm 75PPM / $^{\circ}$ C maximum
Maximum Inaccuracy	0.5% of range (including temperature drift)
Linearity Error (end to end)	\pm 0.037% of range Monotonic with no missing codes
Input Stability and Repeatability	\pm 0.024% of range
Maximum Full Scale Calibration Error	\pm 0.098% of range
Offset Calibration Error	\pm 0.098% of range
Maximum Crosstalk at DC, 50Hz and 60Hz	\pm 0.049% of range
Recommended Fuse (external)	Edison S500-32-R, 0.032 A fuse
External Power Supply Required	24VDC (-20% / + 25%), 30mA

P1-04ADL-1 Analog Input

The P1-04ADL-1 Low Resolution Analog Input Module provides four current sinking channels for converting 0–20 mA analog signals to a digital value of 0–8191 (13-bit) for use with the Productivity1000 system.

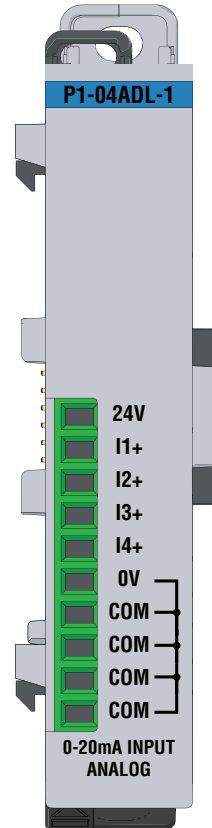

Input Specifications	1
General Specifications	2
Removable Terminal Block Specifications	2
Wiring Diagram and Schematic	3
Module Installation Procedure	4
QR Code	4
Wiring Options	5
Module Configuration	5
Linear Scaling	6
Non-Linear Scaling	6
Warning	8

Terminal Block sold separately, (see wiring options on page 5).

Warranty: Thirty-day money-back guarantee. Two-year limited replacement (See www.productivity1000.com for details).

General Specifications	
Operating Temperature	0° to 60°C (32° to 140°F)
Storage Temperature	-20° to 70°C (-4° to 158°F)
Humidity	5 to 95% (non-condensing)
Environmental Air	No corrosive gases permitted
Vibration	IEC60068-2-6 (Test Fc)
Shock	IEC60068-2-27 (Test Ea)
Field to Logic Side Isolation	1800VAC applied for 1 second
Insulation Resistance	> 10M Ω @ 500VDC
Heat Dissipation	1200mW
Enclosure Type	Open Equipment
Module Location	Any I/O position in a Productivity1000 System
Field Wiring	Removable terminal block (sold separately). Use ZIP Link Wiring System optional See "Wiring Options" on page 5.
EU Directive	See the "EU Directive" topic in the Productivity Suite Help File. Information can also be obtained at: www.productivity1000.com
Terminal Type (sold separately)	10-position Removable Terminal Block
Weight	71g (2.5 oz)
Agency Approvals	UL 61010-2-201 file E139594, Canada & USA CE (EN61131-2 EMC and EN61010-2-201 Safety)*

*See CE Declaration of Conformance for details.

Terminal Block Specifications		
Part Number	P1-10RTB	P1-10RTB-1
Positions	10 Screw Terminals	10 Spring Clamp Terminals
Wire Range	30–16 AWG (0.051–1.31 mm ²) Solid / Stranded Conductor 3/64 in (1.2 mm) Insulation Max. 1/4 in (6–7 mm) Strip Length	28–16 AWG (0.081–1.31 mm ²) Solid / Stranded Conductor 3/64 in (1.2 mm) Insulation Max. 19/64 in (7–8 mm) Strip Length
Conductors	"USE COPPER CONDUCTORS, 75°C" or equivalent.	
Screw Driver	0.1 in (2.5 mm) Maximum*	
Screw Size	M2	N/A
Screw Torque	2.5 lb-in (0.28 N-m)	N/A

*Recommended Screw Driver TW-SD-MSL-1

P1-04ADL-1 Schematic

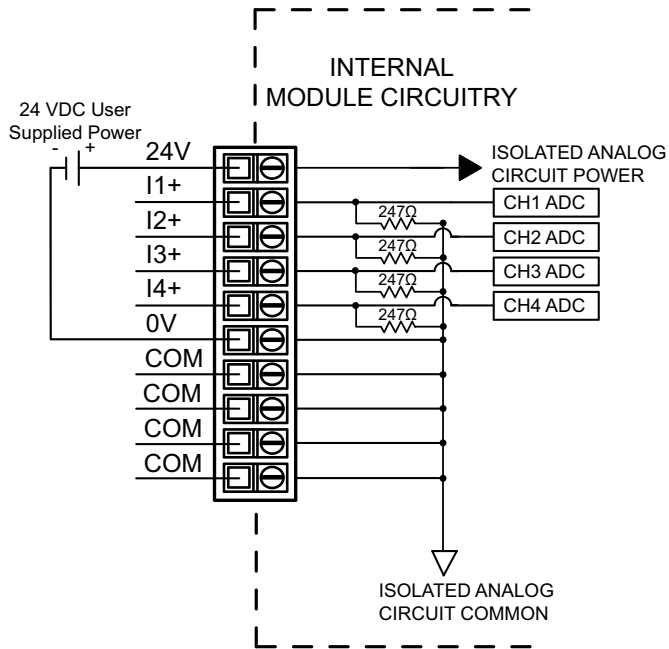

P1-04ADL-1 Wiring Diagram

Current Input Circuits

An Edison S500-32-R 0.032 A fast-acting fuse is recommended for current loops.

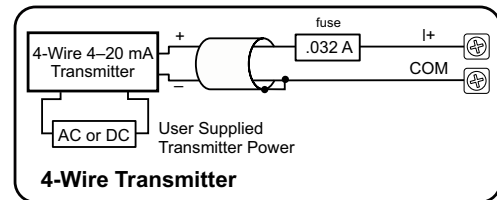
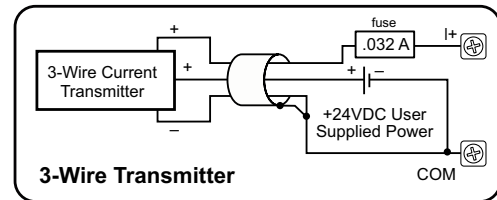
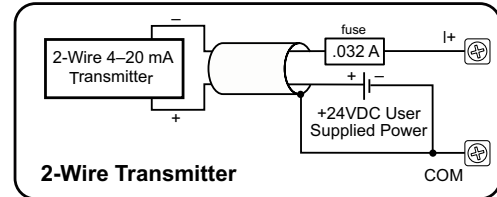

Note: Do not connect both ends of shield.

Module Installation

QR Code

WARNING: Do not add or remove modules with field power applied.

Step One: With latch in "locked" position, align connectors on the side of each module and stack by pressing together. Click indicates lock is engaged.

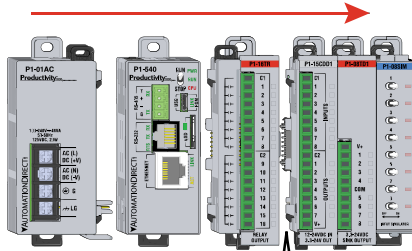

Step Two: Attach field wiring using the removable terminal block or ZIPLink wiring system.

Check all latches are secure after modules are connected.

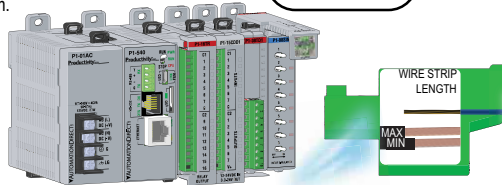

Step Three: To unstack modules, pull locking latch up into the unlocked position and then pull modules apart.

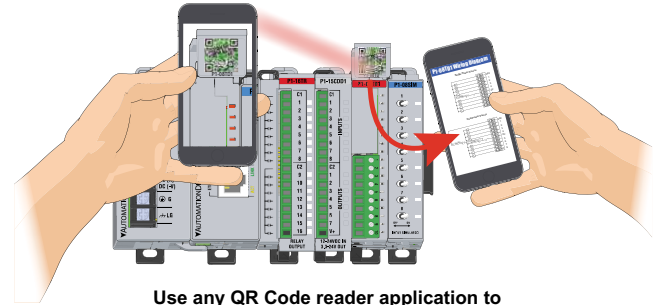
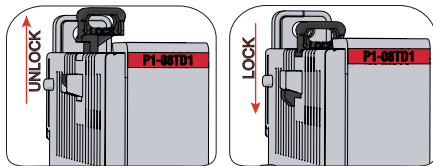

Use any QR Code reader application to display the module's product insert.

Module Configuration

Wiring Options

1 **ZIPLink Connection System**
Cable + ZIPLink Module = Complete System



ZIPLink pre-wired terminal block cables

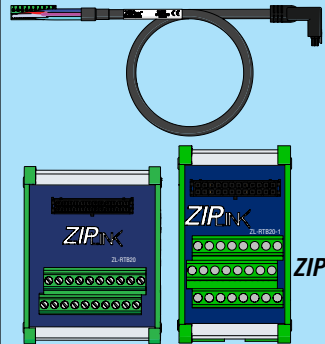

0.5 m (1.6 ft) cable
1.0 m (3.3 ft) cable
2.0 m (6.6 ft) cable

ZIPLink Modules Feed through

ZL-P1-CBL10
 ZL-P1-CBL10-1
 ZL-P1-CBL10-2
 ZL-RTB20
 ZL-RTB20-1

2 **Terminal Block with pigtail cable**

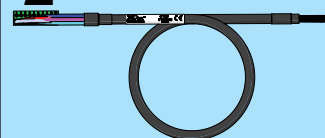

1.0 m (3.3 ft) cable
2.0 m (6.6 ft) cable



ZL-P1-CBL10-1P
 ZL-P1-CBL10-2P

3 **Screw Terminal Block only**



P1-10RTB
 (Quantity 1)

4 **Spring Clamp Terminal Block only**

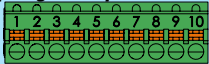

P1-10RTB-1
 (Quantity 1)

Using the Hardware Configuration tool in the Productivity Suite programming software, drag and drop the P1-04ADL-1 module into the configuration.
 If desired, assign a *User Tagname* to each input point (channel) selected and to each *Status Bit Item*.

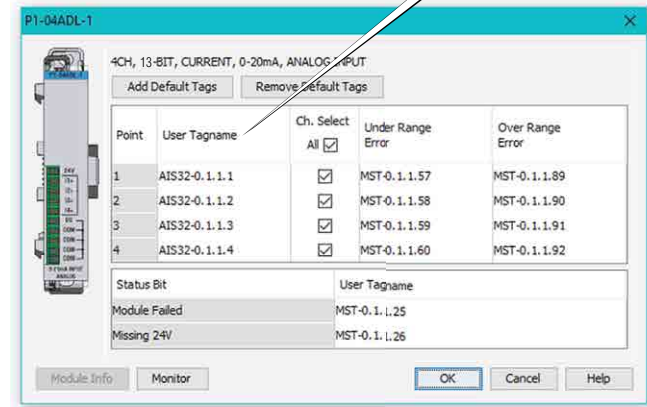

Linear Scaling

The Scale (Linear) function can be used to:

- Convert an application specific range to range which is native to the analog output module.
- Make other linear conversions in ranges appropriate to the application.

Select the Input and Output tags appropriate for the application. Convert raw input signals to engineering units for use in the program, or convert engineering units to output signals for control purposes

Input	Output
min	min
max	max

Non-Linear Scaling

The Scale (Non-Linear) function can be used for Non-Linear applications.

Input value	Desired Output
0	0
1	5
2	1
3	1.55
4	2.25
5	3.07
6	4
6.5	5
7	7
0	0
0	0
0	0
0	0
0	0
0	0

Enter actual output values for each input value break point.

WARNING: To minimize the risk of potential safety problems, you should follow all applicable local and national codes that regulate the installation and operation of your equipment. These codes vary from area to area and it is your responsibility to determine which codes should be followed, and to verify that the equipment, installation, and operation are in compliance with the latest revision of these codes.

Equipment damage or serious injury to personnel can result from the failure to follow all applicable codes and standards. We do not guarantee the products described in this publication are suitable for your particular application, nor do we assume any responsibility for your product design, installation, or operation.

If you have any questions concerning the installation or operation of this equipment, or if you need additional information, please call Technical Support at 770-844-4200.

This publication is based on information that was available at the time it was printed. At AutomationDirect.com® we constantly strive to improve our products and services, so we reserve the right to make changes to the products and/or publications at any time without notice and without any obligation. This publication may also discuss features that may not be available in certain revisions of the product.

Document Name	Edition/Revision	Date
P1-04ADL-1-DS	1st Edition	9/7/2017

Copyright 2017, AutomationDirect.com Incorporated/All Rights Reserved Worldwide