

| Input Specifications | |
|--|---|
| Input Channels | 4 |
| Module Signal Input Range | 0-10VDC |
| Signal Resolution | 16-bit |
| Resolution Value of LSB (least significant bit) | 0-10VDC = 152µV per count (1LSB = 1 count) |
| Data Range | 0-65535 counts |
| Input Type | Single-ended (1 common) |
| Maximum Continuous Overload | ±100V |
| Input Impedance | 250kΩ (typical) |
| Filter Characteristics | Low Pass, -3dB @ 60Hz |
| Sample Duration Time | 7ms per channel (does not include ladder scan time) |
| All Channel Update Rate | 50ms |
| Open Circuit Detection Time | Zero reading within 1s |
| Conversion Method | Successive approximation |
| Accuracy vs. Temperature | ±25PPM / °C maximum |
| Maximum Inaccuracy | 0.1% of range (including temperature drift) |
| Linearity Error (end to end) | ±0.015% of range Monotonic with no missing codes |
| Input Stability & Repeatability | ±0.015% of range (after 10 min. warm-up) |
| Full Scale Calibration Error | ±0.15% of range maximum |
| Offset Calibration Error | ±0.015% of range maximum |
| Max Crosstalk | -76dB, of range maximum |
| External Power Supply Required | 24VDC (-20% / + 25%), 35mA |

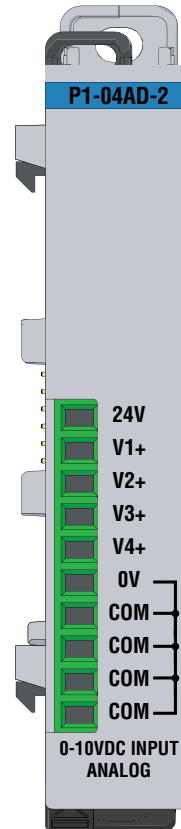

P1-04AD-2 Analog Input

The P1-04AD-2 Voltage Analog Input Module provides four channels for receiving 0-10VDC signals for use with the Productivity1000 system.

Please Note: \$US prices shown

For current \$AUD visit www.directautomation.com.au

| | |
|---|---|
| Input Specifications | 1 |
| General Specifications | 2 |
| Terminal Block Specifications | 2 |
| Wiring Diagram and Schematic. | 3 |
| Module Installation Procedure. | 4 |
| QR Code | 4 |
| Wiring Options. | 5 |
| Module Configuration | 5 |
| Linear Scaling | 6 |
| Non-Linear Scaling | 6 |
| Diagnostic/Status. | 8 |
| Warning | 8 |

Terminal Block sold separately, (see wiring options on page 5).

Warranty: Thirty-day money-back guarantee. Two-year limited replacement (See www.productivity1000.com for details).

| General Specifications | |
|--|--|
| Operating Temperature | 0° to 60°C (32° to 140°F) |
| Storage Temperature | -20° to 70°C (-4° to 158°F) |
| Humidity | 5 to 95% (non-condensing) |
| Altitude | 2,000 meters max |
| Pollution Degree | 2 |
| Environmental Air | No corrosive gases permitted |
| Vibration | IEC60068-2-6 (Test Fc) |
| Shock | IEC60068-2-27 (Test Ea) |
| Field to Logic Side Isolation | 1800VAC applied for 1 second |
| Insulation Resistance | > 10MΩ @ 500VDC |
| Heat Dissipation | 1400mW |
| Overvoltage Category | II |
| Enclosure Type | Open Equipment |
| Module Location | Any I/O position in a Productivity1000 System |
| Field Wiring | Removable terminal block (sold separately). Use ZIP Link Wiring System optional See "Wiring Options" on page 5. |
| Terminal Type (sold separately) | 10-position Removable Terminal Block |
| Weight | 58g (2.0 oz) |
| Agency Approvals | UL 61010-1 and UL 61010-2-201 File E139594, Canada and USA CE (EN 61131-2 EMC, EN 61010-1 and EN 61010-2-201 Safety)* |

*See CE Declaration of Conformance for details.

| Terminal Block Specifications | | |
|-------------------------------|---|---|
| Part Number | P1-10RTB | P1-10RTB-1 |
| Positions | 10 Screw Terminals | 10 Spring Clamp Terminals |
| Wire Range | 30–16 AWG (0.051–1.31 mm ²) Solid / Stranded Conductor 3/64 in (1.2 mm) Insulation Max. 1/4 in (6–7 mm) Strip Length | 28–16 AWG (0.081–1.31 mm ²) Solid / Stranded Conductor 3/64 in (1.2 mm) Insulation Max. 19/64 in (7–8 mm) Strip Length |
| Conductors | "USE COPPER CONDUCTORS, 75°C" or equivalent. | |
| Screw Driver | 0.1 in (2.5 mm) Maximum* | |
| Screw Size | M2 | N/A |
| Screw Torque | 2.5 lb-in (0.28 N-m) | N/A |

*Recommended Screw Driver TW-SD-MSL-1

P1-04AD-2 Schematic

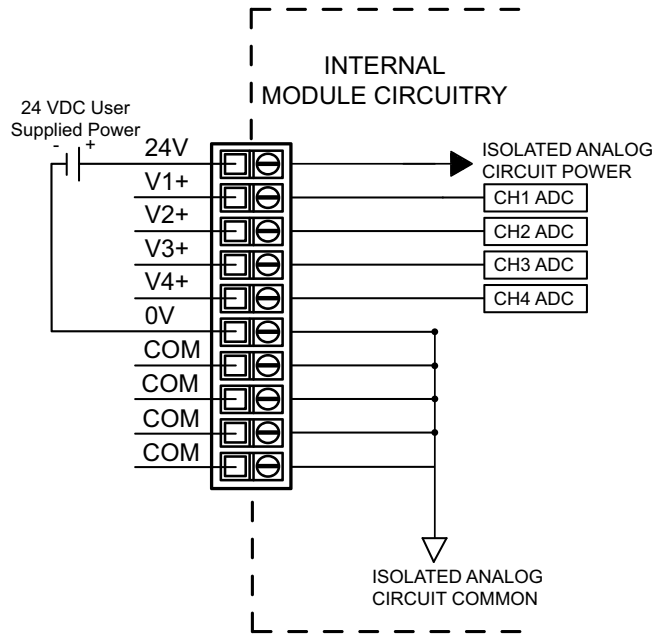

P1-04AD-2 Wiring Diagram

Voltage Input Circuits

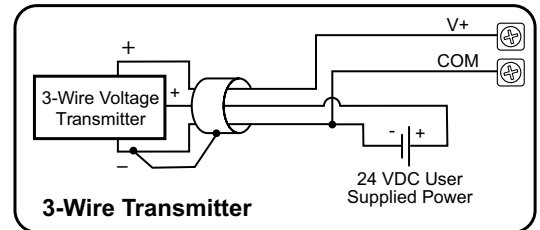
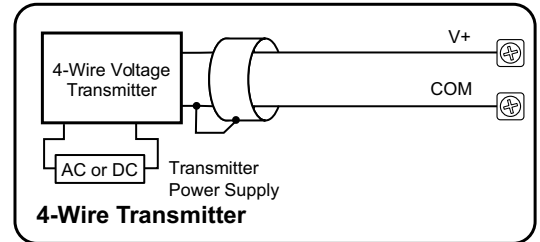

Module Installation

QR Code

WARNING: Do not add or remove modules with field power applied.

Step One: With latch in "locked" position, align connectors on the side of each module and stack by pressing together. Click indicates lock is engaged.

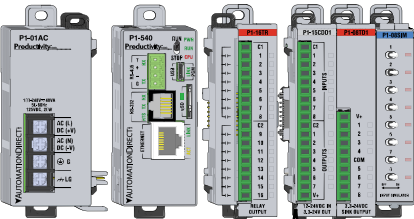

Ensure all latches are secure after modules are connected.

Step Two: Attach field wiring using the removable terminal block or ZIPLink wiring system.

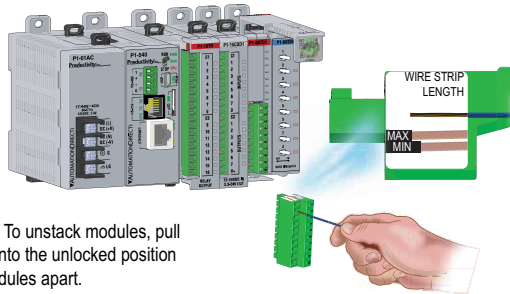

Step Three: To unstack modules, pull locking latch up into the unlocked position and then pull modules apart.

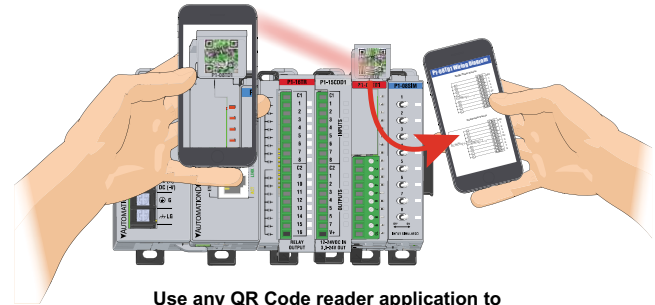
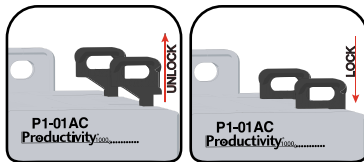

Use any QR Code reader application to display the module's product insert.

Module Configuration

Wiring Options

1 ZIPLink Feed Through Modules and Cables¹

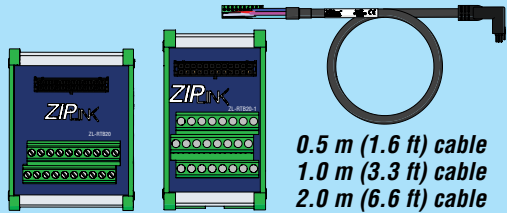

0.5 m (1.6 ft) cable
1.0 m (3.3 ft) cable
2.0 m (6.6 ft) cable



ZL-RTB20
ZL-RTB20-1

ZL-P1-CBL10
ZL-P1-CBL10-1
ZL-P1-CBL10-2

2 Terminal Block with pigtail cable

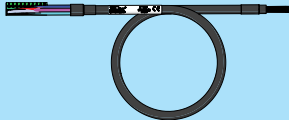

1.0 m (3.3 ft) cable
2.0 m (6.6 ft) cable

ZL-P1-CBL10-1P
ZL-P1-CBL10-2P

3 Screw Terminal Block only

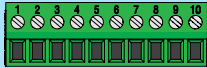

P1-10RTB
(Quantity 1)

4 Spring Clamp Terminal Block only

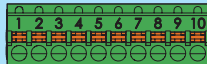

P1-10RTB-1
(Quantity 1)

5 Accessories²



ZL-RTB-COM
TW-SD-SL-1
TW-SD-MSL-1

1. Cable + ZIPLink Module = Complete System
2. ZL-RTB-COM provides a common connection point for power or ground

Using the Hardware Configuration tool in the Productivity Suite programming software, drag and drop the P1-04AD-2 module into the configuration.

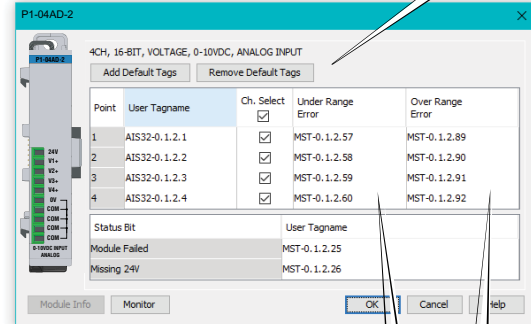

The "Under Range Error" bit for each channel activates for a signal around 0V ± offset error.
The "Over Range Error" bit for each channel activates for a signal around 10V ± gain error.

Linear Scaling

The Scale (Linear) function can be used to:

- Convert an application specific range to range which is native to the analog output module.
- Make other linear conversions in ranges appropriate to the application.

Select the Input and Output tags appropriate for the application. Convert raw input signals to engineering units for use in the program, or convert engineering units to output signals for control purposes

| Input | Output |
|-------|--------|
| 0 | 220 |
| 65535 | 12500 |

Non-Linear Scaling

The Scale (Non-Linear) function can be used for Non-Linear applications.

| Input value | Desired Output |
|-------------|----------------|
| 0 | 0 |
| 1 | 5 |
| 2 | 1 |
| 3 | 1.55 |
| 4 | 2.25 |
| 5 | 3.07 |
| 6 | 4 |
| 6.5 | 5 |
| 7 | 7 |
| 0 | 0 |
| 0 | 0 |
| 0 | 0 |
| 0 | 0 |
| 0 | 0 |
| 0 | 0 |

Enter actual output values for each input value break point.

WARNING: To minimize the risk of potential safety problems, you should follow all applicable local and national codes that regulate the installation and operation of your equipment. These codes vary from area to area and it is your responsibility to determine which codes should be followed, and to verify that the equipment, installation, and operation are in compliance with the latest revision of these codes.

Equipment damage or serious injury to personnel can result from the failure to follow all applicable codes and standards. We do not guarantee the products described in this publication are suitable for your particular application, nor do we assume any responsibility for your product design, installation, or operation.

If you have any questions concerning the installation or operation of this equipment, or if you need additional information, please call Technical Support at 770-844-4200.

This publication is based on information that was available at the time it was printed. At AutomationDirect.com® we constantly strive to improve our products and services, so we reserve the right to make changes to the products and/or publications at any time without notice and without any obligation. This publication may also discuss features that may not be available in certain revisions of the product.

Diagnostic/Status

| Diagnostic/Status | |
|---------------------------------|-------------------|
| <i>Under Range Error</i> | 1 bit per channel |
| <i>Over Range Error</i> | 1 bit per channel |
| <i>Module Failed</i> | 1 bit per module |
| <i>Missing 24V</i> | 1 bit per module |

| Document Name | Edition/Revision | Date |
|---------------|--------------------|----------|
| P1-04AD-2-DS | 1st Edition, Rev A | 2/6/2023 |

Copyright 2022, AutomationDirect.com Incorporated/All Rights Reserved Worldwide