

BX-SERIO Serial Communications

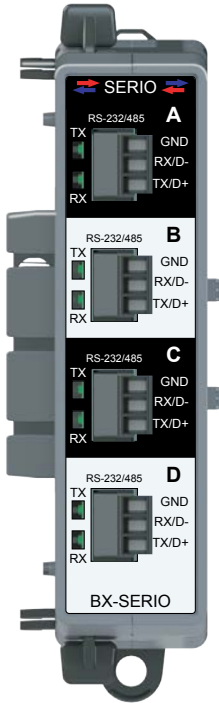

BX-SERIO
\$208.00

4 port, RS-232/RS-485

Four (4) BX-RTB03S Terminal Blocks included.



NOTE: This device does not support ZIPLink Wiring Systems

IMPORTANT!



Hot-Swapping Information
Note: This device cannot be Hot Swapped.

Serial Communications Specifications		
Specification	BX-SERIO	
Number of Ports	Four RS-232/RS-485 serial ports	
Description	Isolated serial port that can communicate via RS-232 or RS-485 (software selectable). Includes ESD protection and built-in surge protection.	
Supported Protocols	Do-more! Protocol (Slave)(Default) Modbus RTU (Master/Slave) K-Sequence (Slave) ASCII (In/Out) DMX512 (Master/Slave)	
Data Rates	1200, 2400, 4800, 9600, 19200, 38400, 57600, and 115200 bps	
Default Settings	RS-232, 115200bps, No Parity, 8 Data Bits, 1 Stop Bit, Station #1, Termination resistor OFF	
Port Status LED	Green LED illuminated when active (TX and RX)	
Port Type	Removable 3-pin terminal strip 3.5 mm pitch	
	RS-232	RS-485
Station Addresses	N/A	1-247
RX/D-	Receive input (RX)	Transceiver low (D-)
TX/D+	Transmit output (TX)	Transceiver high (D+)
GND	Port Ground	
Input Impedance	5kΩ	19kΩ
Terminating Resistor	N/A	120Ω, software selectable
Maximum Load	3kΩ, 1000pf	50 transceivers, 19kΩ each, 120Ω termination
Output Short Circuit Protection	±15mA	±250mA, thermal shutdown protection
Electrostatic Discharge Protection	±1.5 kV per JESD22-C101	±7kV per IEC 61000-4-2
Electrical Fast Transient Protection	±2kV per IEC 61000-4-4	
Min. Output Voltage	±5V with 3kΩ load	Differential: 1.5 V with 60Ω load
Fail Safe Inputs	N/A	Logic high input state if inputs are unconnected
Maximum Common Mode Voltage	500 Vrms to Logic Ground	
Cable Requirements	ADC# L19772-XXX	ADC# L19954-XXX
Maximum Cable Distance	30m [100ft]; 6m [20ft] rec'd max.	1000m [3280ft]
Replacement Connector	ADC Part # BX-RTB03S	
Backplane Power Consumption	1.2 W	
Heat Dissipation	1.2 W	
Weight	85g (3oz)	
Software Version	Do-more! Designer v2.5 or later	

BX-SERIO Field Wiring Diagrams

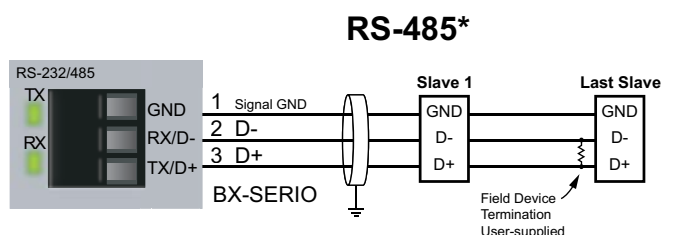
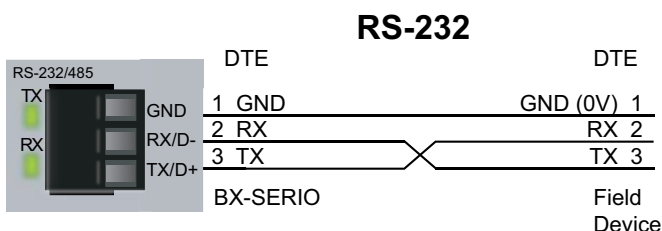

*NOTE: Termination resistor is built-in and software selectable.
ADC # L19827-xxx or equivalent is recommend for RS-485 networks.

BRX Motion Control, Communications and Specialty Expansion Modules

Overview

One of the unique features of the BRX platform is its ability to expand its capability to fit your application solution. One of the ways the BRX platform can do this is by using expansion modules that conveniently "snap on" to the side of any BRX MPU. Once the expansion module has been snapped into place and is added to the project, it instantly adds I/O to the MPU with little to no additional setup required.

The specialty expansion modules give you the ability to add additional high-speed I/O or serial communications as needed. On the front panel of the expansion modules a color scheme and a symbol are used to denote the module type.

High-speed I/O modules have 8-point sinking/sourcing inputs and are available with 8-point sinking or sourcing outputs, all with switching frequencies up to 250kHz. The serial communications modules have 4 serial ports.

The high-speed I/O modules ship without wiring terminals. This allows you to select the termination style that best suits your application. Several wiring options are available, including screw terminal connectors and spring clamp terminal connectors. The serial communications modules ship with a terminal connector installed in each port.

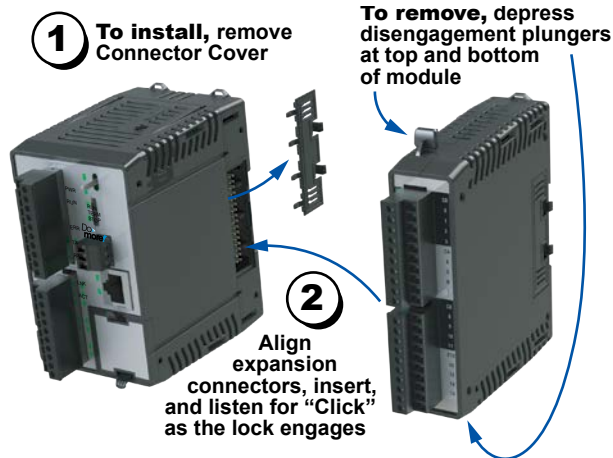

Hot-Swapping Information
 Note: This device cannot be Hot Swapped.

General Specifications

All BRX high-speed input/output modules and serial communications modules have the same general specifications listed in the table below.

General Specifications	
Operating Temperature	0° to 60°C (32° to 140°F)
Storage Temperature	-20° to 85°C (-4° to 185°F)
Humidity	5% to 95% (non-condensing)
Environmental Air	No corrosive gases permitted
Vibration	IEC60068-2-6 (Test Fc)
Shock	IEC60068-2-27 (Test Ea)
Enclosure Type	Open Equipment
Noise Immunity	NEMA ICS3-304
EU Directive	See the "EU Directive" topic in the BRX Help File
Agency Approvals	UL 61010-2 File E185989, Canada and USA, CE Compliant EN61131-2

Dimensions

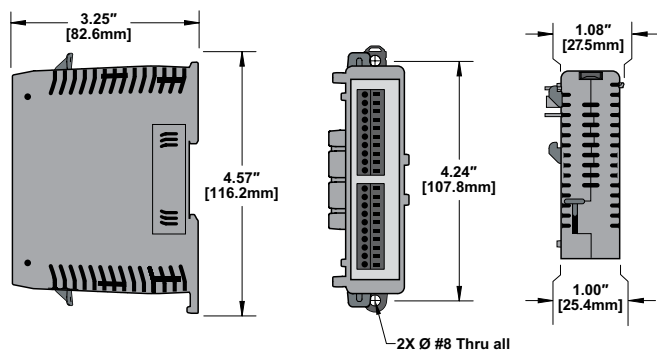

NOTE: When removing an expansion module make sure there is room for the module to slide away from the system. Failure to do so will result in difficulty removing the module.

BRX Motion Control, Communications and Specialty Expansion Modules

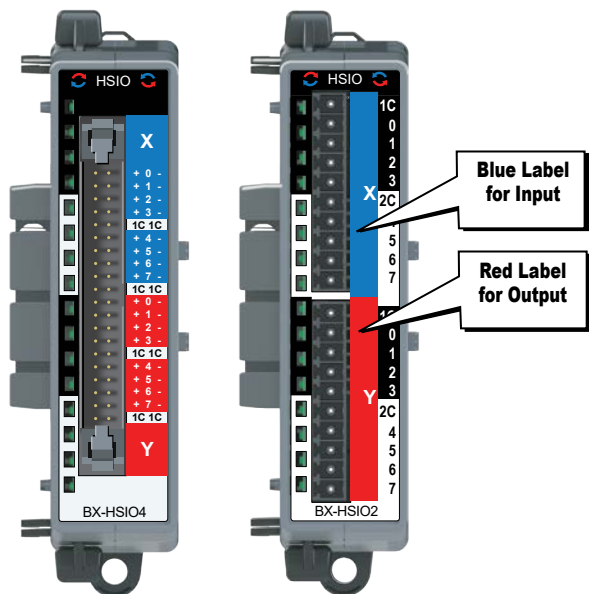

High-speed Input/Output Modules

Three (3) high-speed input/output modules are available, with eight inputs and eight outputs each. High-speed I/O module faceplates have blue and red terminal bar sections to distinguish input and output terminals, respectively, and have the symbol to signify high-speed I/O.

High-Speed Input/Output Modules					
Part Number	Input Points	Output Points	Output Type	Switching Speed	Price
<u>BX-HSIO1</u>	8	8	12–24 VDC Sinking	Up to 250kHz	\$229.00
<u>BX-HSIO2</u>	8	8	12–24 VDC Sourcing	Up to 250kHz	\$229.00
<u>BX-HSIO4</u>	8	8	2.5–5 VDC Sinking/Sourcing	Up to 2MHz	\$259.00

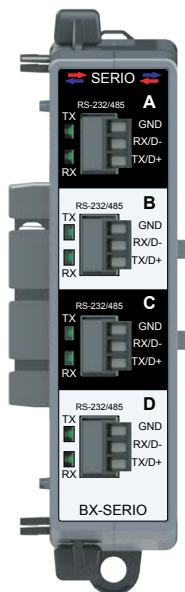

Serial Communications Module

Three (3) serial communications modules are available, with four serial ports each. Serial communications module faceplates have black and white terminal sections to distinguish serial terminals, and have the symbol to signify serial I/O.

Serial Communications Module			
Part Number	Ports	Port Type	Price
<u>BX-SERIO</u>	4	RS-232 / RS-485	\$208.00
<u>BX-SERIO-2</u>	4	RS-232 with Flow Control	\$204.00
<u>BX-SERIO-4</u>	4	RS-422	\$188.00

Expansion Module Support by Controller	
Controller Type	# Expansion Modules
<u>BX-DM1E-M</u>	8
<u>BX-DM1-10</u>	2
<u>BX-DM1E-10</u>	2
<u>BX-DM1-18</u>	4
<u>BX-DM1E-18</u>	8
<u>BX-DM1-36</u>	4
<u>BX-DM1E-36</u>	8
<u>BX-DMIO*</u>	8
<u>BX-EBC100*</u>	8
<u>BX-MBIO*</u>	8

* Remote I/O controllers do not support Motion Control and Communications Modules.