

DC Output Module

P3-64TD1



Sinking Output

The P3-64TD1 DC Output Module provides sixty-four 6-27 VDC sinking outputs with eight isolated commons.

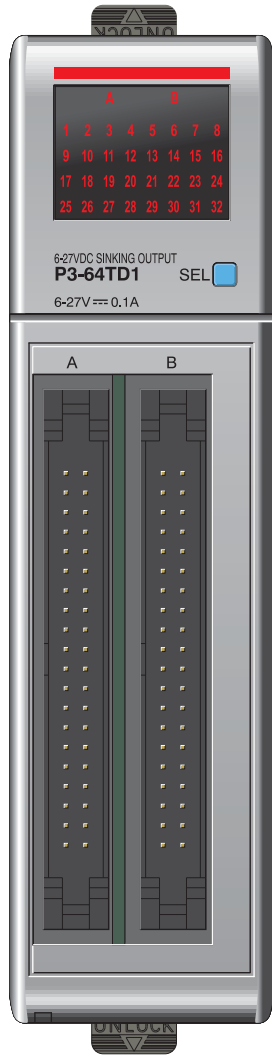

**No terminal block
sold for this module;
ZIPLink required.**

Output Specifications	
Outputs per Module	64 (sinking)
Operating Voltage Range (Tolerance)	CE 6.25 – 24 VDC (-15% / + 20%)
	UL 6 – 27 VDC (-15% / +10%)
Maximum Output Current @ Temp	0.1A / point, 0.8A / common @ 60°C
Minimum Output Current	0.4 mA
Maximum Leakage Current	0.3 mA @ 30 VDC
On Voltage Drop	0.3 VDC @ 0.1A
Maximum Inrush Current	0.5A for 10 ms
OFF to ON Response	≤ 0.2 ms
ON to OFF Response	≤ 0.3 ms
Connector Type	Two 40-pin IDC
Status Indicators	Logic Side (32 points x 2)
Commons	8 Isolated (8 points / common)
External DC Power Required	24VDC ± 10% @ 210mA

General Specifications	
Operating Temperature	0° to 60°C (32° to 140°F)
Storage Temperature	-20° to 70°C (-4° to 158°F)
Humidity	5 to 95% (non-condensing)
Environmental Air	No corrosive gases permitted
Vibration	MIL STD 810C 514.2
Shock	MIL STD 810C 516.2
Field to Logic Side Isolation	1500VAC applied for 1 minute
Insulation Resistance	>10MΩ @ 500 VDC
Heat Dissipation	11.35W
Enclosure Type	Open Equipment
Agency Approvals	UL508 file E157382, Canada & USA UL1604 file E200031, Canada & USA CE (EN61131-2*) This equipment is suitable for use in Class 1, Division 2, Groups A, B, C and D or non-hazardous locations only.
Module Keying to Backplane	Electronic
Module Location	Any I/O slot in any local, expansion, or remote base in a Productivity3000 System.
Field Wiring	Use ZIPLink wiring system. See "Wiring I/O Modules".
EU Directive	See the "EU Directive" topic in the Productivity3000 Help File. Information can also be obtained at: www.productivitypac.com
Weight	160g (5.64 oz)

*Meets EMC and Safety requirements. See the Declaration of Conformity for details.

Connector Specifications	
Connector Type	IDC style header with latch, Omron XG4A-4034
Number of Pins	40 point x 2
Pitch	0.1 in. (2.54 mm)

WARNING: Explosion hazard – Substitution of components may impair suitability for Class I, Division 2.

See "Wiring Systems" for part numbers of ZIPLink cables and connection modules required with this I/O module.



Derating Chart

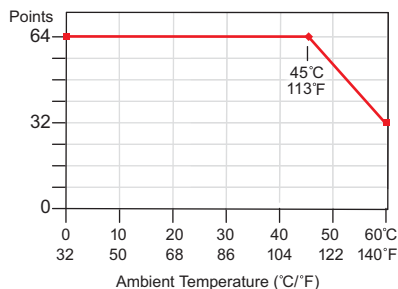

DC Output Module

P3-64TD1 (cont'd)

Wiring Diagrams

Dual Power Source

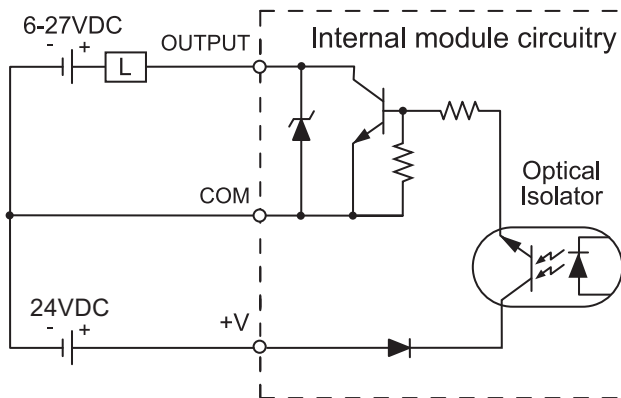
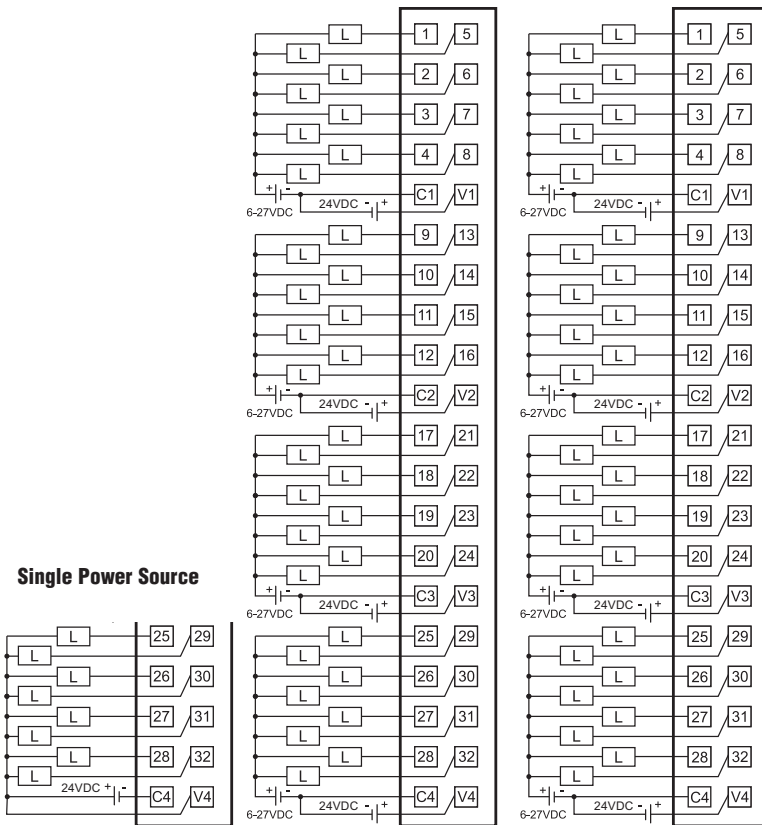
A
B



Specify your ZIPLink system

Use the Compatibility Matrix table below.

Step 1	Locate the I/O module part number.
Step 2	Locate Connector Module Type. (Feedthrough Module, Fuse Module, etc...)
Step 3	Select the cable length by replacing the # symbol with: Blank = 0.5m, -1 = 1.0m, -2 = 2.0m ¹
¹ Note: Cable part number denotes compatibility between Connector Module and I/O Modules.	

Productivity3000 ZIPLink Wiring System Compatibility Matrix								
Step 2: Connector Module Type		Feedthrough Modules		Fuse Modules		Relay Module	Sensor Input Mod.	Pigtail Cable
Step 1: I/O Module	Number of Terminals	ZL-RTB20	ZL-RTB40	ZL-RFU20	ZL-RFU40	ZL-RRL16-24	ZL-LTB16-24	
Step 3: Cables								
Inputs								
P3-08NAS	20	ZL-P3-CBL20#						ZL-P3-CBL20-#P
P3-08ND3S	20	ZL-P3-CBL20#						ZL-P3-CBL20-#P
P3-16NA	20	ZL-P3-CBL20L#						ZL-P3-CBL20-#P
P3-16ND3	20	ZL-P3-CBL20L#						ZL-P3-CBL20-#P
P3-32ND3	40		ZL-CBL40#				ZL-P3-CBL40#	
P3-64ND3*	40		ZL-CBL40#				ZL-P3-CBL40#	
Outputs								
P3-08TAS	20	ZL-P3-CBL20#						ZL-P3-CBL20-#P
P3-08TD1S	20	ZL-P3-CBL20L#						ZL-P3-CBL20-#P
P3-08TD2S	20	ZL-P3-CBL20L#						ZL-P3-CBL20-#P
P3-08TRS	20	ZL-P3-CBL20#						ZL-P3-CBL20-#P
P3-16TA	20	ZL-P3-CBL20#		ZL-P3-CBL20L#				ZL-P3-CBL20-#P
P3-16TD1	20	ZL-P3-CBL20#		ZL-P3-CBL20#		ZL-P3-CBL20#		ZL-P3-CBL20-#P
P3-16TD2	20	ZL-P3-CBL20#		ZL-P3-CBL20#				ZL-P3-CBL20-#P
P3-16TR	20	ZL-P3-CBL20#		ZL-P3-CBL20#				ZL-P3-CBL20-#P
P3-08TRS-1***	20	ZL-P3-CBL20#						ZL-P3-CBL20-#P
P3-32TD1	40		ZL-CBL40#		ZL-CBL40#			
P3-32TD2	40		ZL-CBL40#		ZL-CBL40#			
P3-64TD1*	40		ZL-CBL40#		ZL-CBL40#			
P3-64TD2*	40		ZL-CBL40#		ZL-CBL40#			
Analog In								
P3-04ADS	20	ZL-P3-CBL20L#						ZL-P3-CBL20-#P
P3-08AD	20	ZL-P3-CBL20L#						ZL-P3-CBL20-#P
P3-16AD-1	20	ZL-P3-CBL20L#						ZL-P3-CBL20-#P
P3-16AD-2	20	ZL-P3-CBL20L#						ZL-P3-CBL20-#P
P3-08RTD**	Matched Only							
P3-08THM**	T/C Wire Only							
Analog Out								
P3-04DA	20	ZL-P3-CBL20L#						ZL-P3-CBL20-#P
P3-08DA-1	20	ZL-P3-CBL20L#						ZL-P3-CBL20-#P
P3-08DA-2	20	ZL-P3-CBL20L#						ZL-P3-CBL20-#P
P3-06DAS-1	20	ZL-P3-CBL20L#						ZL-P3-CBL20-#P
P3-06DAS-2	20	ZL-P3-CBL20L#						ZL-P3-CBL20-#P
P3-16DA-1	20	ZL-P3-CBL20L#						ZL-P3-CBL20-#P
P3-16DA-2	20	ZL-P3-CBL20L#						ZL-P3-CBL20-#P
Analog Combo								
P3-8AD4DA-1	20	ZL-P3-CBL20L#						ZL-P3-CBL20-#P
P3-8AD4DA-2	20	ZL-P3-CBL20L#						ZL-P3-CBL20-#P

*The P3-64ND3, P3-64TD1, and P3-64TD2 modules have two 32-point connectors and require 2 ZIPLink cables and 2 ZIPLink connector modules.

**These modules are not supported by the ZIPLink wiring system. Removable terminal block P3-RTB included.

***The P3-08TRS-1 output module is derated, not to exceed 2A per point maximum when used with the ZIPLink wiring system.

I/O Modules

A variety of discrete and analog I/O modules are available for use in local, expansion, and remote I/O bases. Specifications for each module are on the following pages.

A filler module is available for unused I/O module slots (part number P3-FILL).



Discrete Input Modules

Productivity3000 Discrete Input Modules			
Part Number	Number of Inputs	Description	Price
P3-16SIM	16	Input Simulator Module	<--->
P3-08ND3S	8	Isolated Sinking/Sourcing DC Input	<--->
P3-16ND3	16	Sinking/Sourcing DC Input	<--->
P3-32ND3*	32	Sinking/Sourcing DC Input	<--->
P3-64ND3*	64	Sinking/Sourcing DC Input	<--->
P3-08NAS	8	Isolated AC Input	<--->
P3-16NA	16	AC Input	<--->

*ZIPLink required.

Analog I/O Modules

Productivity3000 Analog Input Modules			
Part Number	Number of Channels	Description	Price
P3-04ADS	4	Isolated Analog Input	<--->
P3-08AD	8	Analog Input	<--->
P3-16AD-1	16	Analog Input (Current)	<--->
P3-16AD-2	16	Analog Input (Voltage)	<--->
P3-08RTD	8	Analog RTD Input	<--->
P3-08THM	8	Analog Thermocouple Input	<--->

Productivity3000 Analog Output Modules			
Part Number	Number of Channels	Description	Price
P3-04DA	4	Analog Output	<--->
P3-08DA-1	8	Analog Output (Current)	<--->
P3-08DA-2	8	Analog Output (Voltage)	<--->
P3-06DAS-1	6	Isolated Analog Output (Current)	<--->
P3-06DAS-2	6	Isolated Analog Output (Voltage)	<--->
P3-16DA-1	16	Analog Output (Current)	<--->
P3-16DA-2	16	Analog Output (Voltage)	<--->

Productivity3000 Analog Input/Output Modules			
Part Number	Number of Channels	Description	Price
P3-8AD4DA-1	8/4	Analog Input/Output (Current)	<--->
P3-8AD4DA-2	8/4	Analog Input/Output (Voltage)	<--->

Discrete Output Modules

Productivity3000 Discrete Output Modules			
Part Number	Number of Outputs	Description	Price
P3-08TD1S	8	Isolated Sinking Output	<--->
P3-08TD2S	8	Isolated Sourcing Output	<--->
P3-16TD1	16	Sinking Output	<--->
P3-16TD2	16	Sourcing Output	<--->
P3-32TD1*	32	Sinking Output	<--->
P3-32TD2*	32	Sourcing Output	<--->
P3-64TD1*	64	Sinking Output	<--->
P3-64TD2*	64	Sourcing Output	<--->
P3-08TAS	8	Isolated AC Output	<--->
P3-16TA	16	AC Output	<--->
P3-08TRS	8	Isolated Relay Output	<--->
P3-16TR	16	Relay Output	<--->
P3-08TRS-1	8	Isolated Relay Output	<--->

*ZIPLink required.

Module Installation Procedure

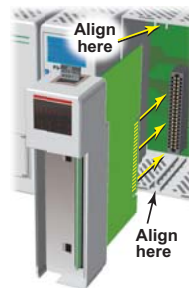

WARNING: Do not apply field power until the following steps are completed. See hot-swapping procedure for exceptions.

Step One: Align circuit card with slot and press firmly to seat module into connector.

Step Two: Pull top and bottom locking tabs toward module face. Click indicates lock is

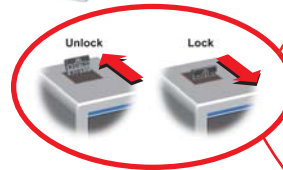

Step Three: Attach field wiring using optional terminal block or ZIPLink wiring system and install cover.



To install or remove terminal block cover, press middle to flex cover.

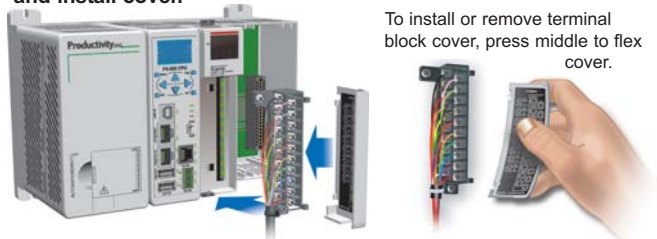

WARNING: Explosion hazard – Do not connect or disconnect connectors or operate switches while circuit is live unless the area is known to be non-hazardous. Do not hot-swap modules unless the area is known to be non-hazardous.